



CASE IH PLANTER PRODUCTIVITY GUIDE

for 2000 Series Early Riser® Planters
with AFS Pro 700 Displays

CASE IH

Case IH Planter Productivity Guide

GENERAL INFORMATION

For years, successful growers have relied on Case IH to lead the way with the ultimate planters for their cropping operations. They have trusted their crop to the timeless design principles of the Early Riser Row Unit, while continuously implementing greater levels of precision and higher efficiency practices in their operations.

Case IH's 2000 series Early Riser Planter is designed with this progressive customer in mind, delivering a new level of efficiency to the agriculture industry. This is achieved through integrated industry-leading technologies, including many factory-fit Precision Planting components. These improvements allow growers to continue to reap the benefits of earlier emergence and higher net effective stands that they have achieved with Early Riser planters for years, all at the higher speeds needed to stay competitive in today's industry.

The planter row unit must consistently place the seed into direct contact with moist soil, at a uniform depth, with even in-row seed spacing. The 2000 series row unit maintains the agronomic design true to the Early Riser name, with a greater level of durability and ruggedness for higher planting speeds.

Equalizing gauge wheels are pulled, not pushed, by the row unit. Gauge wheels easily "walk" over residue and clods to minimize depth variation, and are more stable at faster ground speeds and adverse field conditions. Then, the Early Riser row unit uses offset double disk openers to slice a trench through heavy residue and hard soil. The low angle opener and specially-contoured gauge wheels produce a uniform trench, and retain moist soil next to the trench. A furrow forming point defines the seed trench and forms loose soil, creating the perfect seed delivery environment. Patented covering disks gently squeeze the trench closed, returning moist soil over the seed. Finally, a wide press wheel lightly firms soil on top of the furrow to eliminate air pockets, ensuring optimal seed-to-soil contact for quick germination.

This guide is intended to serve as a reference and not as a replacement for the Operations Manual. For more detailed information on safe operation of equipment and planter systems, please reference the appropriate machine Operations Manual and the Case IH Advanced Farming Systems™ (AFS) software operations guide.



The **vSet® 2 Vacuum Seed Meter** was co-developed with Case IH and Precision Planting engineers specifically for the Early Riser planter. This meter, combined with vDrive® electric drive, ensures precise per-row seed metering with simplicity and less maintenance. The mini-hopper's or on-row hopper's single air-intake screen is easy to access and clean. In fact, the entire seed meter offers fast, easy and, yes, tool-free maintenance and adjustments – even when switching between crops.



CONTENTS

General Information	2-3
Planter Configurations	4-5
Operation	6-9
Service	10-17
Adjustments	18-34
Planter Options	35-37
Precision Farming Options	38-39
Monitors and Displays	40-54
Storage	55

GENERAL INFORMATION

The unique chevron tread pattern scores the soil to encourage surface cracking for easier emergence in crust-prone soils. **The attention to seed placement accuracy delivered by the Early Riser is evidenced by proven emergence on average from one to three days faster than with other planter row units.**

The 2000 series Early Riser Planter combines the industry's most accurate planter technologies with an all-new rugged row unit and toolbar for fast and uniform emergence. This next-generation technology, along with the ease of use you need to meet optimal planting windows, gives your crop the best opportunity to achieve its full yield potential.

Case IH offers a selection of planter designs to suit customer's transport needs, including fold configuration and transport width. The 2000 series Early Riser folds as narrow as 12 ft. 4 in. (12R30, 16R30) on 2150 models, and 15 ft. 4 in. (24R30, 32R30, 36R30) on 2160 models. Quick moves from field to field to help you spend more time planting and less time moving between fields when conditions are right. Once again, Early Riser planter advantages get your crop in the ground and growing faster than other planters. Add total planter control and continuous planter performance feedback using the AFS Pro 700 or AFS Pro 1200 display. Add the Advance Seed Information (ASI) option for detailed seed placement information and/or AFS Connect™ for 2-way file transfer for the ultimate in modern planting accuracy and efficiency.

The best-in-class bulk fill option cuts seed fill time to a minimum with twin easy to reach hoppers on and 2140/2150/2160 and a single hopper on the 2130 model that cover more acres between fills. A simple high volume fan system efficiently moves seed from the bulk fill hoppers to row unit mini-hoppers to keep planting up to speed, and row unit weight consistent. This system also means simpler tank cleanout for less seed loss and quick change-over between seed types.



SEED DELIVERY OPTIONS



As a factory installed option the **Precision Planting Wave Vision seed sensor** can be ordered. The mid-mount seed sensor (located above the shoe) is an advanced microwave seed sensor. This sensor works particularly well in conditions with high dust and wind where optical sensor performance can be impacted. (Note: Only corn & soybeans have been validated for use during Spring 2021)



The **Seed Tube** option (left) is optimized for accuracy at faster planting speeds, using DICKEY-john® Hy Rate Plus 10 LED self-calibrating seed sensors for accuracy in a range of seed sizes and field conditions.



The **Advanced Seed Delivery™ (ASD™)** (below) option delivers the highest level of seed placement accuracy. This includes the Precision Planting SpeedTube, which uses a flighted belt to control the delivery of the seed from the meter to the furrow, eliminating the drop and tumble variability of traditional gravity drop tubes at speeds up to 10 mph.

Case IH Planter Productivity Guide

PLANTER CONFIGURATIONS

Case IH Early Riser® 2000 Series Planters are available in multiple configurations to match any farming operation:

2160 Large Front-Fold

- 24R30
- 32R30
- 36R20
- 36R22
- 36R30
- 47R15/24R30
Split Row



2150 Front-Fold

- 12R30
- 16R30
- 24R30



2140 Pivot-Transport

- 23R15/12R30
Split Row
- 24R15/12R30
Split Row
- 31R15/16R30
Split Row
- 32R15/16R30
Split Row
- 24R20
- 24R22



2130 Stack-Fold

- 12R30
- 12R36
- 12R38
- 12R40
- 16R30
- 18R30



Case IH Planter Productivity Guide

OPERATION

REMOVING THE PLANTER FROM STORAGE

1. Clean hydraulic hose couplers before connecting to the tractor.
2. Make sure tires are properly inflated before moving the planter.
3. Remove protective grease and clean exposed cylinder rods.
4. Carefully raise the planter, making sure settling during storage, or other closely-parked equipment does not result in interference when raising and moving the planter.
5. Verify vacuum hoses are securely connected.
6. Inspect the entire planter for signs of rodent or other damage. Check hydraulic hoses and wiring harnesses for proper routing, and tie strap as needed.
7. Lubricate all grease fittings. Do not over-grease fittings lubricated when the unit was put in storage.
8. Cover bulk fill hopper bottom with 50/50 graphite/talc mix.
9. Clean seed tubes/SpeedTubes and seed sensors.
10. Close air compressor drain.
11. Read the Operator's Manual for both the planter and display operation.
12. Reconnect, charge, and test the planter battery.



OPERATION

TRACTOR/PLANTER HOOKUP

Several important factors must be considered when matching the tractor to the planter. The Tractor/Planter Preparation section of the Operator's Manual lists specific requirements for your planter configuration. General factors are:

- Minimum tractor PTO horsepower
- Minimum tractor weight and balance
- Minimal number of remote hydraulic valves
- PTO compatibility with planter hydraulic pump, if equipped
- Adequate 12 volt electrical system capacity
- 3-point hitch (if applicable), 2-point hitch (if applicable), or drawbar (if applicable) requirements
- Tractor tread width adjustable to row spacing

Some specific details that apply to general tractor/planter compatibility requirements include:

- Horsepower and Weight Requirements must be met to maintain control of the planter in the field and transport situations. This is especially important when operating on hilly or unstable soil when additional control is required.
- Low Back Pressure Case Drains on all 2000 series planters. Low pressure is defined as less than 25 PSI under full-flow conditions. Refer to your tractor Operator's Manual for correct low-pressure return connections for your tractor.
 - A hydraulic case drain port is required for all 2000 series planters. A warning tag on the case drain hose reminds the operator that incorrect connection of the case drain may damage the vacuum fan motor. Motor failures due to improper case drain connection are not covered by warranty.
- Hydraulic PTO pump (if equipped) supplies various planter hydraulic circuits. Refer to specific tractor installation instructions for PTO pump torque restraint kits.
- Tractor 3-point hitch adjustments should be set according to planter Operator Manual instructions. For example, sway adjustment will vary between hitch-mounted toolbar planters, and a drawn planter using the 3-point hitch quick coupler connection to the tractor.
- Electrical system requirements include the standard seven-pin connector socket for safety lighting, a nine-pin connector for planter power and communications, and AFS system wiring.
- Tractor requirements vary widely depending upon the size of planter and type of hitch arrangement. Always refer to the Operator Manual for information pertaining specifically to your planter.

When hookup is complete, thoroughly inspect the routing of all hoses and electrical harnesses between the tractor and planter.

- Steer the tractor/planter combination through complete right and left turns, raise and lower the tractor or planter hitch while observing routing to assure no interference develops during operation and maneuvering.



Case IH Planter Productivity Guide

OPERATION

LEVELING THE PLANTER

To achieve proper levelness of the planter the tractor hitch must be properly set at operating position for planting. Keep in mind, because the parallel links are curved, the distance from the ground to each parallel link bolt likely will not be the same. The line drawn on the image below depicts this difference. Each row unit has the capability of +/- 8 inches of travel and should be near the mid point when leveled.

1. Measure

Distance between the ground and the front and rear of the toolbar should be equal.

If not, follow step 2.

2. Adjust

- Planter should be in level field area prepared for planting
- The tool bar, hitch and wings of the planter should all be made level with the ground and checked for accuracy with a digital level, if possible.
- When the planter is lowered to the operating position, the toolbar will be parallel to ground
 - *Drawbar Hitch units – adjust the clevis to the correct position to achieve desired height*
 - *2 Point/3 Point units – use tractor hitch controls to achieve and set desired height*
 - *If hitch adjustment is inadequate, carrying wheel height is adjusted by changing mounting location on support arms (2130, 2150, 2160 only)*



GENERAL PLANTING TIPS

Several important factors must be considered when planting.

General factors are:

- **Always be moving forward when lowering planter into planting position**
 - Lowering the planter to planting position while stationary may cause plugging at the seed shoe
- **Dig often** to check seed depth and seed spacing accuracy.
- **Frame remote operation varies by planter configuration.**
 - **2140/2160** – operate with frame remote powered down
(moving the frame remote to float maybe required in rugged terrain or for marker ground following)
 - **2150** – After powering the planter down move to the float position to allow markers (if equipped) to float
- **Check tractor hydraulic flow adjustments** for each planter function running direct from tractor after reaching operating temperature.

NOTE: It is recommended that flow levels be set just above the required amount for each circuit to reduce the potential for overheating and power consumption.

OPERATION

PLANTING WITH AN ELECTRIC DRIVE PLANTER

Electric drive planters require different operating techniques than hydraulic drive planters. Follow these guidelines for consistent seed spacing and population across the field, especially at the start and end of each pass.

MAINTAIN CONSISTENT ENGINE RPM

- 1800-1900 RPM recommended (see tractor ops manual for details)
- To decelerate the tractor, always downshift to a lower gear to maintain engine RPM
- Avoid throttling down, which can cause unwanted seed gaps from vacuum fan pressure drop

AVOID SUDDEN CHANGES IN SPEED

- When shifting gears while planting, shift one gear at a time
- Sudden speed changes may cause unwanted seed gaps

PLANTER SYSTEMS (START)

- Press and hold for 3 seconds starts all necessary systems – vacuum, bulk fill (if equipped), alternator, wing down force (if equipped), liquid fertilizer (if equipped), compressor, plus prime the meters



PRIME CONTROL

- Loads seed meters to prepare for planting

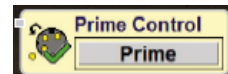

JUMP START

- Allows product application drives to start early when accelerating from a complete stop
- Drives apply using a Jump Start speed until it is exceeded by actual ground speed

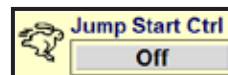

'STOP PLANT' FEATURE

- Operator raises the planter to pre-set height before slowing to a stopped position, disengaging product drives

PLANTER SYSTEMS (STOP)

- Turns off all planter systems initiated with Planter Systems (Start).



Case IH Planter Productivity Guide

SERVICE

TAKE FULL ADVANTAGE OF YOUR DEALER SERVICE INSPECTION CAPABILITIES

Have you, or did someone you know purchase a new planter in the last few years and continued to use it in much the same way as the planter it replaced? Many times operators do not fully realize and take advantage of modern features. As a result of not fully utilizing the planter's features, the owner may not be getting all the value from the money spent. Many of the items suggested in this booklet can be completed by the owner when preparing for the season or the operator when starting a new field. Other adjustments, service procedures, or repairs might be more effectively completed by your dealer's trained service technicians.

Ask your Case IH dealer about Customized Maintenance Inspections. It is a proactive way to be sure your planter will operate at its best possible performance when you need it. Customized Maintenance Inspections include a visual and functional inspection of your planter. They can be used as a pre-season or as a post-season tune-up.



Benefits include:

- Increased productivity
- Less downtime during the season
- Lower operating costs
- Improved fuel economy
- Documented maintenance
- Service by Case IH-trained technicians
- Service with Genuine Case IH lubricants, filters, and parts

The combined advantages of Customer Maintenance Inspection services should result in a lower cost of ownership and higher resale values.

SERVICE

CHECKLIST FOR YOUR 2000 SERIES EARLY RISER PLANTER

	OK	Replace/ Adjust		OK	Replace/ Adjust
PRESS WHEEL			PNEUMATIC DOWN PRESSURE (IF EQUIPPED)		
1. Splits, cracks	<input type="checkbox"/>	<input type="checkbox"/>	27. Air compressor filter (clean or replace)	<input type="checkbox"/>	<input type="checkbox"/>
2. Chevron bars/center rib	<input type="checkbox"/>	<input type="checkbox"/>	28. Air compressor oil level (inspect, annual replacement)	<input type="checkbox"/>	<input type="checkbox"/>
3. Bearing	<input type="checkbox"/>	<input type="checkbox"/>	29. Air tank (drain, inspect)	<input type="checkbox"/>	<input type="checkbox"/>
4. Down pressure spring and cartridge condition	<input type="checkbox"/>	<input type="checkbox"/>	30. Air lines (leaks, damage, etc.)	<input type="checkbox"/>	<input type="checkbox"/>
CLOSING DISC			ON-ROW SEED HOPPER (IF EQUIPPED)		
5. Diameter (min. 8 in.)	<input type="checkbox"/>	<input type="checkbox"/>	31. Hopper condition	<input type="checkbox"/>	<input type="checkbox"/>
6. Bearing and cap condition	<input type="checkbox"/>	<input type="checkbox"/>	32. Hopper lid	<input type="checkbox"/>	<input type="checkbox"/>
7. Spring and cartridge condition, or air cylinder condition (if equipped)	<input type="checkbox"/>	<input type="checkbox"/>	BULK FILL OPTION (IF EQUIPPED)		
RESIDUE MANAGERS			33. Tank lid seal	<input type="checkbox"/>	<input type="checkbox"/>
8. Air cylinder and rod boot condition (if equipped)	<input type="checkbox"/>	<input type="checkbox"/>	34. Inductor box door seals	<input type="checkbox"/>	<input type="checkbox"/>
OPENER DISC SCRAPER			35. Hydraulic fan motor (oil leaks)	<input type="checkbox"/>	<input type="checkbox"/>
9. Cleans openers properly (replace as needed)	<input type="checkbox"/>	<input type="checkbox"/>	36. Air leaks – hoses, induction box	<input type="checkbox"/>	<input type="checkbox"/>
OPENER DISCS			MARKER DISCS (IF EQUIPPED)		
10. Diameter (min 14.5 in.)	<input type="checkbox"/>	<input type="checkbox"/>	37. Disc condition	<input type="checkbox"/>	<input type="checkbox"/>
11. Clearance between openers (0 mm-3 mm) (3 shims behind lead opener, 4 shims behind trailing opener)	<input type="checkbox"/>	<input type="checkbox"/>	38. Bearing condition	<input type="checkbox"/>	<input type="checkbox"/>
GAUGE WHEELS			GRANULAR CHEMICAL (IF EQUIPPED)		
12. Rubber/rim condition	<input type="checkbox"/>	<input type="checkbox"/>	39. Discharge tube	<input type="checkbox"/>	<input type="checkbox"/>
13. Clearance to disc (0 - 1/8 in. max.)	<input type="checkbox"/>	<input type="checkbox"/>	LIQUID FERTILIZER (IF EQUIPPED)		
14. Wobble arm	<input type="checkbox"/>	<input type="checkbox"/>	40. Tank, filter, flow meter, and all lines clean	<input type="checkbox"/>	<input type="checkbox"/>
15. Pivot arm pins	<input type="checkbox"/>	<input type="checkbox"/>	41. Orifices installed and clean	<input type="checkbox"/>	<input type="checkbox"/>
ROW UNIT PARALLEL LINKAGE			42. Section valves and individual row shutoffs (if equipped) – clean and function	<input type="checkbox"/>	<input type="checkbox"/>
16. Linkage poly bushings – replace before worn completely through	<input type="checkbox"/>	<input type="checkbox"/>	43. Coultter wear/damage (if equipped)	<input type="checkbox"/>	<input type="checkbox"/>
SEED SHOE			44. In-furrow nozzle condition, clean/not blocked (if equipped)	<input type="checkbox"/>	<input type="checkbox"/>
17. Excessive wear at bottom and side of shoes	<input type="checkbox"/>	<input type="checkbox"/>	45. Calibrate	<input type="checkbox"/>	<input type="checkbox"/>
DEPTH CONTROL			ELECTRICAL		
18. Row units zeroed (if parts were replaced)	<input type="checkbox"/>	<input type="checkbox"/>	46. Wire harnesses/tie straps	<input type="checkbox"/>	<input type="checkbox"/>
SEED METERING SYSTEM			47. Fuses	<input type="checkbox"/>	<input type="checkbox"/>
19. Seed meter cover seal (wear points visible, deformation)	<input type="checkbox"/>	<input type="checkbox"/>	48. Seed tube & SpeedTube sensor (function/LED), clean	<input type="checkbox"/>	<input type="checkbox"/>
20. Seed disc, seed holes	<input type="checkbox"/>	<input type="checkbox"/>	49. Hopper seed level sensor	<input type="checkbox"/>	<input type="checkbox"/>
21. Singulator	<input type="checkbox"/>	<input type="checkbox"/>	50. Wheel speed sensor (if equipped) (approx. 0.1 in. air gap)	<input type="checkbox"/>	<input type="checkbox"/>
22. Ejector wheel	<input type="checkbox"/>	<input type="checkbox"/>	51. Monitor (operation, functionality)	<input type="checkbox"/>	<input type="checkbox"/>
23. Brush condition	<input type="checkbox"/>	<input type="checkbox"/>	52. Battery fully charged, battery holding charge	<input type="checkbox"/>	<input type="checkbox"/>
24. Seed tube condition	<input type="checkbox"/>	<input type="checkbox"/>	TRACKS (IF EQUIPPED)		
25. SpeedTube belt, feeder wheel, rumble strip condition	<input type="checkbox"/>	<input type="checkbox"/>	53. Track and idler condition	<input type="checkbox"/>	<input type="checkbox"/>
26. Vacuum lines (condition, obstructions)	<input type="checkbox"/>	<input type="checkbox"/>	54. Idler oil level	<input type="checkbox"/>	<input type="checkbox"/>
			55. Track alignment	<input type="checkbox"/>	<input type="checkbox"/>
			OTHER/ATTACHMENTS (IF EQUIPPED)		
			56. Frames	<input type="checkbox"/>	<input type="checkbox"/>
			57. Welds	<input type="checkbox"/>	<input type="checkbox"/>
			58. Tire pressure/inflation	<input type="checkbox"/>	<input type="checkbox"/>
			59. Hydraulic hose routings	<input type="checkbox"/>	<input type="checkbox"/>
			60. Hydraulic oil reservoir level (PTO pump only)	<input type="checkbox"/>	<input type="checkbox"/>

Case IH Planter Productivity Guide

SERVICE

DAILY MAINTENANCE

Daily maintenance on Case IH planters is limited to a few simple lubrication and component checks.

Grease points

- Identify by reviewing the maintenance section of your planter Operator Manual
- Lubricate all frame pivots and driveshaft grease fittings (if equipped)

Air Compressor

- Drain air tank at least once daily
 - Auto Drain Kit available through your Case IH dealer – **PN: 51447993**
- Clean pneumatic air filter(s) daily, replacing as needed
- Check oil level, and add synthetic 15W-50 engine oil as needed

PTO Pump System (if equipped)

- Check fluid level in PTO pump reservoir, adding CASE IH HY-TRAN PREMIUM as needed
- Check fins on PTO pump fluid cooler for plugging, cleaning with shop air or low pressure wash as needed



VERIFYING PLANTER PERFORMANCE AND “AS REQUIRED” MAINTENANCE

Early Riser row unit maintenance is described in the Operator Manual as “as required” service functions. This means that units can be operated without need for specific maintenance checks as long as meter function is to standard, and seed placement and seed furrow opener performance is satisfactory.

Defining “as required” maintenance is quite simply to “get out and dig” behind the planter to check performance

- Recommended throughout the day on varying rows until a full planter inspection is completed at least once per day
- Maintain enough down pressure to prevent row unit bounce and potential poor seed placement
- This is especially important when starting each season; or when making planter changes or adjustments
- Turn off air pressure to closing systems (if equipped), lift closing disks with a strap, and lock press wheel in transport position to access closing system components.



A Check depth on seed trench opening disks (**A & B**). Seed depth should be checked from the press wheel impression to the seed. Do not measure from the gauge wheel impressions, or the surface of the soil between the row unit gauge wheel tracks.



C Check furrow forming point depth (**C**).



D Check seed spacing and placement to confirm seed meter accuracy and setting (**D**).



E Closing Disks OR V-press wheel – Confirm covering disk action and seed trench closure (**E**).



F Verify press wheel (if equipped) function (**F**).

SERVICE

vSet 2[®] SEED METER REMOVAL & INSPECTION

Refer to Ops Manual for further instructions

1. Remove the seed hopper and meter
 - Disconnect wiring harness connector, vacuum hose and bulk fill seed hose coupler (if equipped)
NOTE: When removing the seed hose coupler, care should be exercised so that the sealing O-ring does not become dislodged from the coupler.
 - Disconnect the seed hopper by unlatching the hopper (mini hopper and on-row hopper) from the row unit
 - Remove the seed hopper by tilting the hopper up (mini hopper and on-row hopper) and lifting out of row unit assembly
 - Remove seed meter assembly from the seed hopper by unlatching spring latch and lifting out of seed hopper
 - A pin style meter retention was used in production for 2021.
A pin style Meter Retention Kit is available from your Case IH dealer – **PN: 90402170**
2. Disassemble the seed meter
 - Disconnect the two seed meter retention springs from the locking tabs on the meter housing to remove the seed meter cover
 - Remove clip from seed disc shaft, and remove the seed disc
3. Inspect and clean meter and hopper components:
 - Mini Hopper or On-Row Hopper (if equipped)
 - Remove mesh vent to clear debris
 - Meter
 - Vacuum seal – inspect for wear and deformation, which may require replacement
 - Meter housing – clear debris, clean with soap and water
 - Meter cover – clear debris, clean with soap and water
 - Seed ejector wheel – inspect for excessive wear and to check for binding
 - Air vents – clear of debris, clean with soap and water
 - Singulator
 - Clear debris from behind singulator
 - Should be seated fully into the tabs on the singulator mounting spring
 - Inspect lobes for wear. If flat spots have developed, replace the singulator
 - Check radial spring for detent. Ensure the ends of the radial spring are seated in the holes of the seed cover wall and that the radial spring is retained behind the two tabs on the seed cover wall.
 - Brushes (upper and lower)
 - Clear debris, and replace brushes if seed leakage occurs.
 - Seed disc
 - Primary indicator is reduction in planting performance. Performance issues can be caused by:
 - Seed holes are not round
 - Agitator pockets are severely worn
 - Drive teeth are worn or damaged
 - Disc has become warped



Case IH Planter Productivity Guide

SERVICE

SEED TUBE & SPEEDTUBE™ MAINTENANCE

Refer to Ops Manual for further instructions

Seed Tube Inspection & Cleaning (if equipped)

- Remove seed hopper and meter from row unit, as formerly explained
- Use cleaning brush provided with your planter

OPTION 1 (most thorough clean) – Remove Seed Tube from housing by disconnecting connector and lifting. Clip cable ties, and wipe the seed sensor clean. Reinstall cable sensor with new cable ties. Clean the inside of the seed tube thoroughly using a cleaning brush and a clean cloth. Rinse with clear water. The seed tube must be completely dry prior to re-use.

OPTION 2 (quick clean) – With Seed Tube still in housing, run cleaning brush down seed tube or raise planter and run cleaning brush up from tube bottom.

SpeedTube™ Inspection & Cleaning (if equipped)

- Remove seed hopper and meter from row unit housing, as formerly explained
- Unplug the connector, remove SpeedTube™ from row unit mount, and unscrew optical sensor
- Open SpeedTube™ assembly by compressing the housing tab and rotating the side cover about the hinge as shown
- SpeedTube™ Inspections:
 - Feeder wheels: check for wear or damage
 - Soybean deflector (if applicable): check for wear or damage
 - Belt – check belt tension. If required, reset tension by loosening the idler pulley set screw to allow the spring to tension the belt, then re-tighten the set screw.
 - Rumble strip – check for wear or missing nubs
 - Sensor windows – clean, free of debris
 - Inspect pulleys, feeder wheels, belt, and belt track for dirt



SERVICE

2000 SERIES EARLY RISER ROW UNIT INSPECTION

When servicing ground-engaging components, use care to avoid injury on parts worn sharp by contact with the soil.

- Refer to the Operator's Manual maintenance section for the proper procedures for replacing components.

A walking beam suspension between the two gauge wheels and the row unit opener frame allows one gauge wheel to pass over a rock or clod.

- From the factory, there are typically 3 shims behind leading opener disk, and 4 shims behind trailing opener disk. If opener plugging is experienced as opener disks wear, one shim may be removed from trailing opener disk.
 - Acceptable for disks to touch lightly at some points
- A furrow forming point **(A)** finishes the trench by shaping the soil at the bottom of the trench into a consistent flat bottom for optimum soil-to-seed contact and germination.
- Inspect seed shoe, and replace if it is worn through. Replace furrow forming point when seed shoe is replaced. Inspection gauge no longer needed for replacement of forming point.
- Opener disks should be replaced when they are worn to a 14-1/2 in. diameter.
- Inspect opener disk scrapers. Opener disk scrapers are not adjustable, and should be replaced when they are no longer able to keep disks clean in your soil and planting conditions.

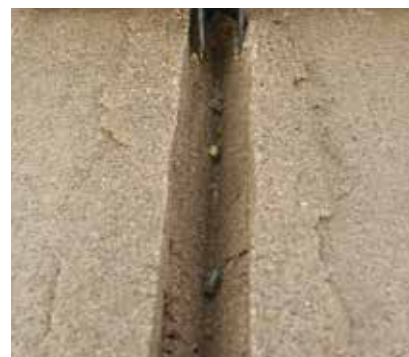
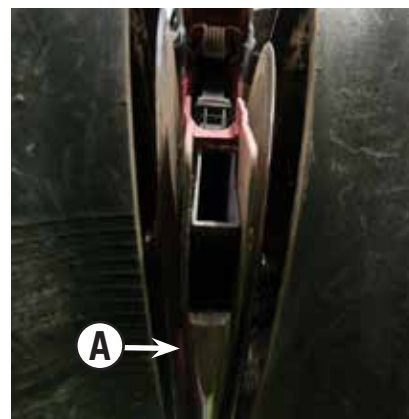

Case IH Planter Productivity Guide

SERVICE

BULK FILL HOPPER INSPECTION

Some simple checks should be performed on bulk hopper systems to assure proper operation.

- Lid seal condition and integrity
- If the lid gasket does not appear to contact the lid evenly, adjustment of the hinges and latches may be helpful in maintaining a more airtight seal
- Remove debris from the bulk fill fan screen
- Clean bulk fill inductor box by opening clean-out doors. Seed tank will drain unless the blockoff plate is installed. (see images below)
- Inspect inductor box seals for signs of air leaks
- Clean bulk fill bin level sensors for seed treatment and lubricant build up



Blockoff Plate Stored



Blockoff Plate in Use

SERVICE

LIQUID FERTILIZER (IF EQUIPPED)

The 2000 series liquid fertilizer system uses a variable flow rate centrifugal pump, inline filter, flowmeter (feedback), pressure sensor, agitation nozzle (in tank), 3 sectional control valves, applicator orifices, and nozzle body check valves to control the application rate. The pump supplies sufficient flow (gpm, l/min) to supply the needs of the flowmeter and agitation circuit. Pump flow rate is controlled by the AFS Pro 700 system, based on the desired application rate input by the operator. These components require regular inspection and maintenance to assure accurate application rates throughout the entire planting season.

DAILY MAINTENANCE

- **Drain all liquid fertilizer from tanks.**
Flush liquid fertilizer system with water after daily use. Do not allow water-diluted fertilizers to remain in the fertilizer system overnight or longer. Salts will separate from the dilution and clog the system.
- **Inspect all hoses for wear, twists, or cracks.**
Repair or replace as necessary.
- **Inspect applicator orifice.**
Flush or clean as required if flow is diminished.
- **Inspect oil level sight glass** (wet seal pumps only)

Note: Do not run pump dry. Seal damage will occur.

SEASONAL MAINTENANCE

Prior to storing planter, prepare the Liquid Fertilizer system with the following:

1. Drain tanks and flush with water.
2. Disconnect supply hoses and check valve caps.
3. Clean orifices with water and allow to dry before storing.
4. Disconnect flowmeter assembly and clean with water. Reinstall flowmeter.
5. Flush the liquid fertilizer system with RV antifreeze (propylene glycol) if located in an area where freezing may occur.

Note: Leave applicator lines and check valves open to aid in evaporating moisture from system.

GRANULAR CHEMICAL SYSTEM (IF EQUIPPED)

SEASONAL MAINTENANCE

1. Remove all transfer containers
2. Clean material from base container thoroughly using protective gear
3. Install rain cover back onto same row unit from which it was removed
4. Contact AMVAC directly for secondary transfer containers for consolidating chemical, if desired.



Agitation nozzle at tank bottom



Case IH Planter Productivity Guide

ADJUSTMENTS

BULK FILL SYSTEM TROUBLESHOOTING DIAGRAM

Seed not flowing or low seed flow to the mini-hopper

1. Turn the bulk fan OFF and verify seed is in the problematic mini-hopper.
2. Verify fan is operating at recommended speed. See charts on pg. 22-25.
3. Check that the inductor box blockoff plate is not in place.
4. Verify the correct inductor box air baffle is inserted into the distribution box. Refer to the 'Recommended settings chart' in the Operator's Manual for details or refer to chart on pg. 22-25.

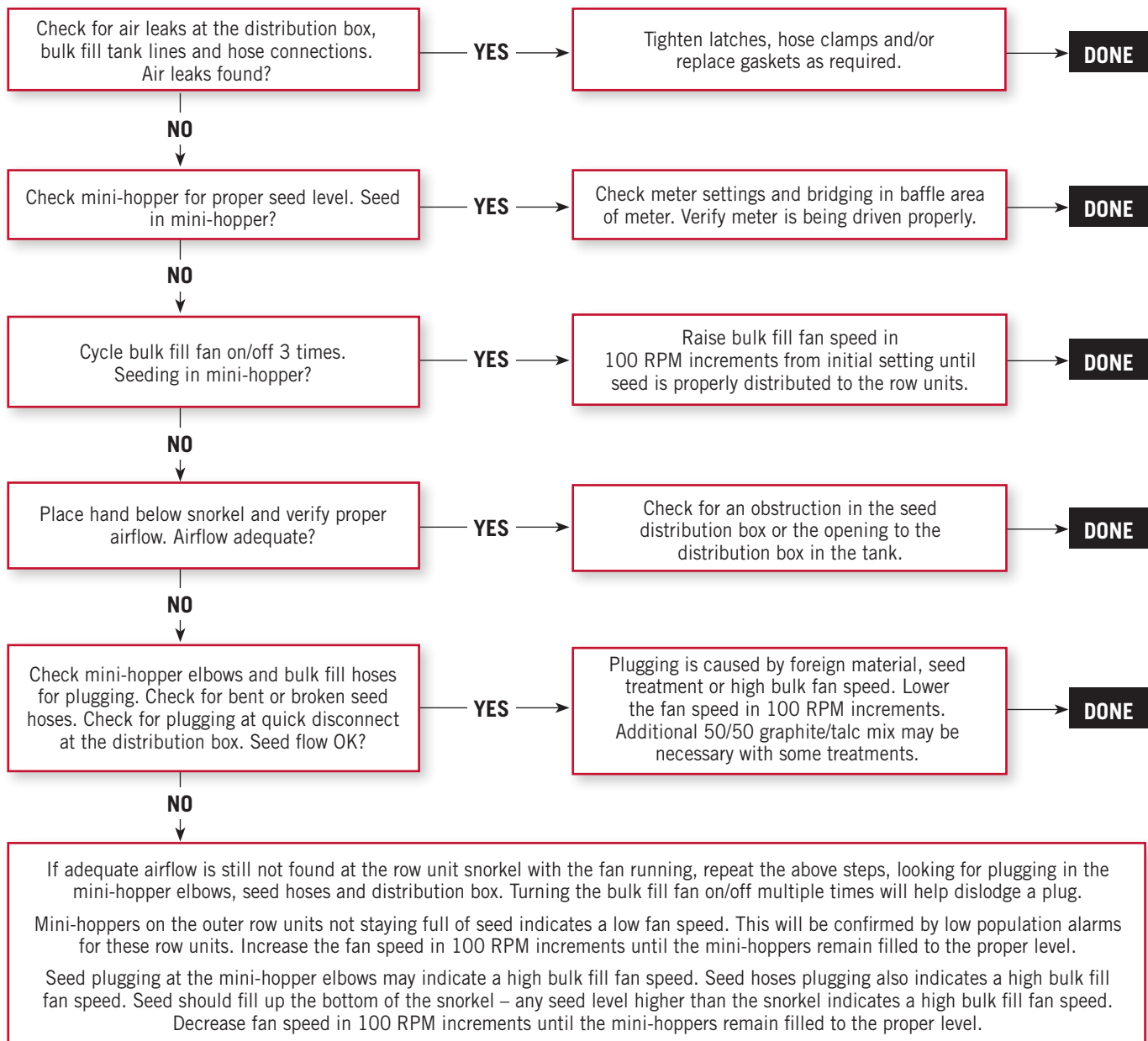

NOTE: Additional seed flow lubricant may be necessary when using seed coated with treatments.

ADJUSTMENTS

CASE IH IRON GARD 50/50 GRAPHITE/TALC MIX

Refer to the planter Operator's Manual for lubricant application rates for new planter hoppers and first fill.

- Talc may improve flow characteristics by bonding to the sticky coating.
- Excess talc can result in buildup on meter and seed contact components
- 50/50 ratio results in most uniform seed flow performance with minimal talc buildup.

Bayer CropScience Fluency Agent is also an acceptable seed flow lubricant that can be used in place of 50/50 graphite/talc.

SEED LUBRICANT RATES	
SEED (BU.)	50/50 GRAPHITE/TALC BLEND(CUPS)
2	1/8
5	1/4
6	3/8
8	1/2
10	3/4
15	1
20	1-1/4
25	1-1/2
30	2
40	2-1/2
50	3
60	3-1/2

Note: 1 lb. of graphite/talc mixture = approx. 3 cups



PART #	DESCRIPTION
407486R1	CNH Spec 1 lb. 100% Graphite Fine Particle Size (for Cyclo and ASM)
73340733	CNH Spec 8 lb. 100% Graphite Fine Particle Size (for Cyclo and ASM)
73340370	CNH Spec 1 lb. 50% Talc 50% Graphite Fine Particle Size (for ASM and 2000 Series Planters with vSet2 Seed Meters)
73340734	CNH Spec 8 lb. 50% Talc 50% Graphite Fine Particle Size (for ASM and 2000 Series Planters with vSet2 Seed Meters)
73341461	All Makes 1 lb. 100% Graphite
73341463	All Makes 1 lb. 80% Talc 20% Graphite
73343904	All Makes Fluency Agent Advanced 4.5 lb., Seed Lubricant (for all Seed Meters)

Case IH Planter Productivity Guide

ADJUSTMENTS

POPULATION ADJUSTMENTS

- All population adjustments for the electric drive system are made through the AFS Pro 700 display. Check the seed disc selection chart to be sure the proper disc is installed.
- Press "Seed Ctrl" to adjust the target seeding rate (shown).

Verify seed meter performance by taking the time to open the trench and check seed placement and spacing, counting the seed population over a specified row length.

- The table below indicates the row length required to be opened to equal 1/1000th of an acre

METER ADJUSTMENTS

- Adjust the baffle to the correct setting per the recommended settings chart on pg. 22-25 (Corn and Soybeans are both "2").
- Move the seed meter baffle adjustment handle to control the depth of seed in the meter housing that is exposed to the seed disc.

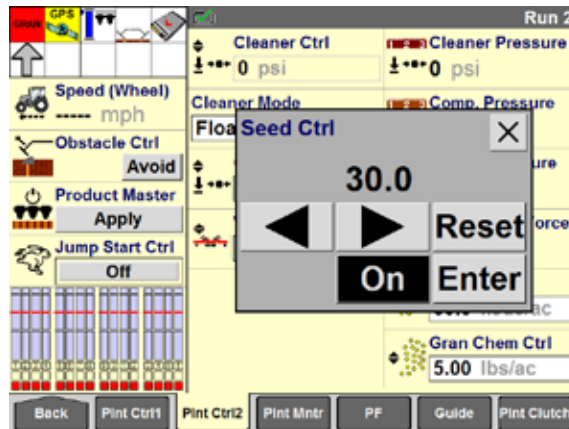

Row Width (in)	Row Length (ft) = 1/1000 ac.
15	34.8
20	26.2
22	23.8
30	17.4
36	14.5
38	13.8
40	13.1



SOYBEAN DEFLECTOR (SPEEDTUBE UNITS ONLY)*

- To switch to soybeans, installation of a Soybean Deflector (A) is required to prevent seeds jamming between feeder wheels.

* Soybean deflector not required with 56 cell soybean disc (see Recommended Settings Chart for more details)

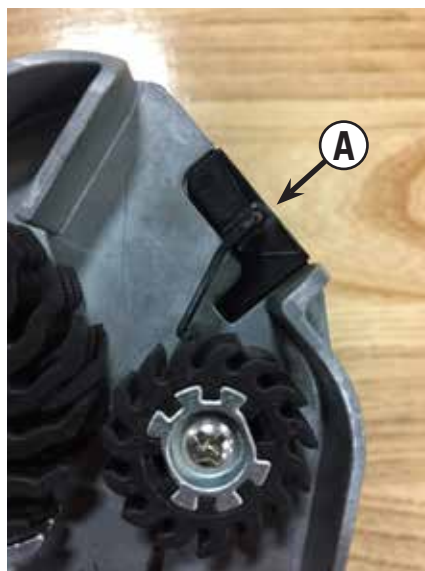

ADJUSTMENTS

SEED POPULATION/SPACING CHART

SEED SPACING	SEED POPULATION						
	Seed/Acre 15 inch rows	Seed/Acre 20 inch rows	Seed/Acre 22 inch rows	Seed/Acre 30 inch rows	Seed/Acre 36 inch rows	Seed/Acre 38 inch rows	Seed/Acre 40 inch rows
0.25 in.	1,672,704	1,254,528	1,140,480	836,352	696,960	660,278	627,264
0.50 in.	836,352	627,264	570,240	418,176	348,480	330,139	313,632
0.75 in.	557,568	418,176	380,160	278,784	232,320	220,093	209,088
1.00 in.	418,176	313,632	285,120	209,088	174,240	165,069	156,816
1.25 in.	334,540	250,906	228,096	167,270	139,392	132,056	125,453
1.50 in.	278,784	209,088	190,080	139,392	116,160	110,046	104,544
1.75 in.	238,958	179,218	162,926	119,479	99,566	94,325	89,609
2.00 in.	209,088	156,816	142,560	104,544	87,120	82,535	78,408
2.25 in.	185,856	139,392	126,720	92,928	77,440	73,364	69,696
2.50 in.	167,270	125,453	114,048	83,635	69,696	66,028	62,726
2.75 in.	152,064	114,048	103,680	76,032	63,360	60,025	57,024
3.00 in.	139,392	104,544	95,040	69,696	58,080	55,023	52,272
3.25 in.	128,670	96,502	87,729	64,335	53,612	50,791	48,251
3.50 in.	119,478	89,609	81,463	59,739	49,783	47,163	44,805
3.75 in.	111,514	83,635	76,032	55,757	46,464	44,019	41,818
4.00 in.	104,544	78,408	71,280	52,272	43,560	41,267	39,204
4.25 in.	98,394	73,796	67,087	49,197	40,998	38,840	36,898
4.50 in.	92,928	69,696	63,360	46,464	38,720	36,682	34,848
4.75 in.	88,038	66,028	60,025	44,019	36,682	34,751	33,014
5.00 in.	83,636	62,726	57,024	41,818	34,848	33,014	31,363
5.25 in.	79,652	59,739	54,309	39,826	33,189	31,442	29,870
5.50 in.	76,032	57,024	51,840	38,016	31,680	30,013	28,512
5.75 in.	72,726	54,545	49,586	36,363	30,303	28,708	27,272
6.00 in.	69,696	52,272	47,520	34,848	29,040	27,512	26,136
6.25 in.	66,908	50,181	45,619	33,454	27,878	26,411	25,091
6.50 in.	64,334	48,251	43,865	32,167	26,806	25,395	24,126
6.75 in.	61,952	46,464	42,240	30,976	25,813	24,455	23,232
7.00 in.	59,740	44,805	40,731	29,870	24,891	23,581	22,402
7.25 in.	57,680	43,260	39,327	28,840	24,033	22,768	21,630
7.50 in.	55,756	41,818	38,016	27,878	23,232	22,009	20,909
7.75 in.	53,958	40,469	36,790	26,979	22,483	21,299	20,234
8.00 in.	52,272	39,204	35,640	26,136	21,780	20,634	19,602
8.25 in.	50,688	38,016	34,560	25,344	21,120	20,008	19,008
8.50 in.	49,198	36,898	33,544	24,599	20,499	19,420	18,449
8.75 in.	47,792	35,844	32,585	23,896	19,913	18,865	17,922
9.00 in.	46,464	34,848	31,680	23,232	19,360	18,341	17,424
9.25 in.	45,208	33,906	30,824	22,604	18,837	17,845	16,953
9.50 in.	44,018	33,014	30,013	22,009	18,341	17,376	16,507
9.75 in.	42,890	32,167	29,243	21,445	17,871	16,930	16,084
10.00 in.	41,818	31,363	28,512	20,909	17,424	16,507	15,682
10.25 in.	40,798	30,598	27,817	20,399	16,999	16,104	15,299
10.50 in.	39,826	29,870	27,154	19,913	16,594	15,721	14,935
10.75 in.	38,900	29,175	26,523	19,450	16,208	15,355	14,588
11.00 in.	38,016	28,512	25,920	19,008	15,840	15,006	14,256
11.25 in.	37,172	27,878	25,344	18,586	15,488	14,673	13,939
11.50 in.	36,364	27,272	24,793	18,182	15,151	14,354	13,636
11.75 in.	35,590	26,692	24,266	17,795	14,829	14,048	13,346
12.00 in.	34,848	26,136	23,760	17,424	14,520	13,756	13,068
12.25 in.	34,136	25,603	23,275	17,068	14,224	13,475	12,801
12.50 in.	33,454	25,091	22,810	16,727	13,939	13,206	12,545
12.75 in.	32,798	24,599	22,362	16,399	13,666	12,947	12,299
13.00 in.	32,168	24,126	21,932	16,084	13,403	12,698	12,063
13.25 in.	31,560	23,670	21,518	15,780	13,150	12,458	11,835
13.50 in.	30,976	23,232	21,120	15,488	12,907	12,227	11,616
13.75 in.	30,412	22,810	20,736	15,206	12,672	12,005	11,405
14.00 in.	29,870	22,402	20,366	14,935	12,446	11,791	11,201
14.25 in.	29,346	22,009	20,008	14,673	12,227	11,584	11,005
14.50 in.	28,840	21,630	19,663	14,420	12,017	11,384	10,815
14.75 in.	28,350	21,263	19,330	14,175	11,813	11,191	10,632
15.00 in.	27,878	20,909	19,008	13,939	11,616	11,005	10,454

Case IH Planter Productivity Guide

ADJUSTMENTS

SEED METER, VACUUM, AND BULK HOPPER RECOMMENDED SETTINGS

The vSet® 2 Seed Meter will accurately plant most seeds. This chart is a guideline to help optimize performance. It provides the range setting for seed sizes best suited for respective discs.

CROP		FIELD CORN		SWEET CORN				SOYBEAN	
Attribute		All		Small	Medium	Large	X-Large	All	
Seeds/lb		1,000-2,500	2,500-2,800 □	2,000-4,600				2,000-4,500	
Max planting rate (seed/sec)		32 ■■						135 ■■	120 ■■
Seed meter setting									
Crop Kit ‡ part number									
Seed disc	Name	Corn	Specialty	Specialty	Specialty	Specialty	Specialty	47779569‡	51479757‡
	# of holes	27	27	27	27	27	27	Soybean	Soybean
	Hole size (in)	0.176	0.155	0.125	0.135	0.145	0.155	80	56
	Part number	73368257	73368283	73368280	73368281	73368282	73368283	73368263	51479743
Singulator	Name	Corn	Corn	Corn	Corn	Corn	Corn	Soybean	Corn
	Part number	47779567	47779567	47779567	47779567	47779567	47779567	47852593	47852593
Ejector	Name	Corn	Specialty	Specialty	Specialty	Specialty	Specialty	Soybean	Soybean
	Part number	47779566	47780001	47780001	47780001	47780001	47780001	47779570	51478891
Additional components	Name							Soybean deflector ◆	
	Part number							47946742	
Baffle position		2	2	4	4	4	4	2	2
Vacuum setting (in-H2O)◇◇		20 ■	20 ■	18-22	18-22	18-22	18-22	20 ◇	20 ◇
Hy Rate Plus™ seed tube compatible		Yes		Yes				Yes	
SpeedTube™ compatible		Yes		No				Yes ◆◆	
WaveVision® seed tube compatible		Yes		No				Yes	
Bulk-fill settings (if equipped)									
Inductor box air baffle*		Large seed*		Large seed*				Large seed*	
2130 Mounted Stacker 12-row	Bulk fan speed	3,500 RPM		3,700 RPM				3,200 RPM	
	Baffle part number	84594223		84594223				84594223	
2130 Mounted Stacker 16-row	Bulk fan speed	3,500 RPM		Not validated for this configuration				3,200 RPM	
	Baffle part number	51533810						51533810	
2140 Pivot-Transport	Bulk fan speed	3,600 RPM		3,700 RPM				3,600 RPM	
	Baffle part number	51530439		51530439				51530439	
2150 12/16-row	Bulk fan speed	3,500 RPM		3,700 RPM				3,300 RPM	
	Baffle part number	84594215		84594215				84594215	
2150 24-row	Bulk fan speed	3,200 RPM		3,700 RPM				3,300 RPM	
	Baffle part number	90434463●●		90434463●●				90434463●●	
2160 32-row, 36-row	Bulk fan speed	3,000 RPM		3,000 RPM				3,000 RPM	
	Baffle part number	51570223		51570223				51570223	
2160 24-row, 47-row	Bulk fan speed	2,400 RPM		Not validated for this configuration				3,100 RPM	
	Baffle part number	51570223						51570223	

‡ The dark shaded background indicates components that are included in the Crop Kits.

* Large seed air baffles are factory installed in the inductor boxes of all 2100 series planters equipped with the bulk-fill option.

◇◇ If using the heavy duty air seal (part number 51479926), an additional 1 in H₂O - 5 in H₂O vacuum pressure may be required.

■■ Planting rate calculation: Row spacing (in.) X Population (seeds/acre) X Speed (mph) / 356,400 = seeds/second

■ Up to 25 in-H₂O vacuum pressure may be required for best results with the SpeedTube™ option.

□ For seeds/lb greater than 2,500, the standard Corn disk may also work acceptably. Test the seed for a final selection.

●● For 2150 24-row planters with PINs prior to YKS085024, air baffle 84594223 should be used unless the planter has been updated with seed flow splitters.

◇ Up to 25 in-H₂O vacuum pressure may be required for best results with the SpeedTube™ option.

◆ The soybean deflector is only required when running the 80-cell soybean disk with SpeedTube™ option. The deflector is installed on the SpeedTube™ housing.

◆◆ When using the SpeedTube option, the 56-cell soybean disk is recommended for optimal feeding unless the maximum planting rate of 120 seeds/second is exceeded, then the 80-cell soybean disk is recommended. For gravity drop seed tubes, either soybean disk (80 or 56 cell) is acceptable as long as the maximum planting rate is not exceeded.

SUNFLOWER						
Edible large	Edible small	#1	#2	#3	#4	Extra small
2,000-4,000		3,000-10,000				>10,000

COTTON		
Singulated	2-seed hilldrop	3-seed hilldrop
4,200-6,300		
35 ■■		

PUMPKIN	
Canning	Ornamental

47779568‡	47779568‡					
Corn	Corn	Specialty	Specialty	Specialty	Specialty	Specialty
27	27	27	27	27	27	27
0.176	0.176	0.155	0.135	0.115	0.115	0.100
73368257	73368257	73368283	73368281	73368279	73368279	73368278
Corn	Corn	Corn	Corn	Corn	Corn	Corn
47779567	47779567	47779567	47779567	47779567	47779567	47779567
Corn	Corn	Specialty	Specialty	Specialty	Specialty	Specialty
47779566	47779566	47780001	47780001	47780001	47780001	47780001
Large seed upper brush						
47902637						
4	4	4	4	3	2	2
12-13	11-12	11-12	11-12	7-8	6-7	6-12
Yes						
No						
No						

73383183‡	47818855‡	51581119‡
Cotton	2-seed hilldrop	3-seed hilldrop
32	40	39
0.115	0.115	0.115
73383182	73368275	51554843
Corn	Soybean	Soybean
47779567	47852593	47852593
Sugar beet	2-seed hilldrop	3-seed hilldrop
47780005	47780002	47780003
	Up Restrict Brush	Up Restrict Brush
	47819349	47819349
1	1	1
20-22	10-30	10-30
Yes		
Yes <input type="checkbox"/>	No	
No		

Specialty	Specialty
27	27
0.125	0.125
73368280	73368280
Corn	Corn
47779567	47779567
Specialty	Specialty
47780001	47780001
3	3
11-12	12-14
Yes	
No	
No	

Small seed
2,800 RPM
47397656
Pending
47397656
2,800 RPM
47397652
3,200 RPM
47397652
3,200 RPM
47397656
2,700 RPM
47397660
Not validated for this configuration

Large seed*
2,400 RPM
84594223
Not validated for this configuration
51533810
3,500 RPM
51530439
3,000 RPM
84594215
3,000 RPM
90434463**
2,700 RPM
51570223
Not validated for this configuration

Not validated for this configuration

‡ The dark shaded background indicates components that are included in the Crop Kits.

* Large seed air baffles are factory installed in the inductor boxes of all 2100 series planters equipped with the bulk-fill option.

■■ Planting rate calculation: Row spacing (in.) X Population (seeds/acre) X Speed (mph) / 356,400 = seeds/second

□□ To plant cotton with the SpeedTube™ option you must replace the standard SpeedTube™ feeder wheels with cotton feeder wheels.

Case IH Planter Productivity Guide

ADJUSTMENTS

SEED METER, VACUUM, AND BULK HOPPER RECOMMENDED SETTINGS

Continued from previous page.

CROP		SUGAR BEETS / ONIONS ▲			EDIBLE BEANS •		
Attribute		<9.5/64"	>9.5-11.5/64"	>11.5/64"	Small	Medium	Large
Seeds/lb					>2,000	1,300-2,000	<1,300
Max planting rate (seed/sec)							

Seed meter setting		SUGAR BEETS / ONIONS ▲			EDIBLE BEANS •		
Crop Kit‡ part number		47818859‡	47818862‡	47818862‡	47779569‡	73343542‡	47818851‡
Seed disc	Name	Small sugar beet	Large sugar beet	Large sugar beet	Soybean	Medium edible bean	Large edible bean
	# of holes	32	32	32	80	70	32
	Hole size (in)	0.062	0.086	0.086	0.155	0.170	0.210
	Part number	73368271	73368267	73368267	73368263	73379218	73368998
Singulator	Name	Corn	Corn	Corn	Soybean	Medium edible bean	Soybean
	Part number	47779567	47779567	47779567	47852593	73379219	47852593
Ejector	Name	Sugar beet	Sugar beet	Sugar beet	Soybean	Soybean	Large edible bean
	Part number	47780005	47780005	47780005	47779570	47779570	47780004
Additional components	Name					Large seed upper brush	Large seed upper brush
	Part number					47902637	47902637
Baffle position		1	1	1	2	3	4
Vacuum setting (in-H2O) ◇◇		10-20	10-20	10-20	18-22	18-24	18-26
SpeedTube™ compatible		Yes			Yes ▲▲		
		No	No	Yes	No		
		No			No		

Bulk-fill settings (if equipped)		SUGAR BEETS / ONIONS ▲			EDIBLE BEANS •		
Inductor box air baffle*		Small seed			Large seed*		

Model	Configuration	Bulk fan speed	Baffle part number	Setting
2130 Mounted Stacker 12-row	Bulk fan speed	3,200 RPM		Pending
	Baffle part number	47397656		84594223
2130 Mounted Stacker 16-row	Bulk fan speed	3,200 RPM		4,300 RPM
	Baffle part number	47397656		51533810
2140 Pivot-Transport	Bulk fan speed	3,200 RPM		3,600 RPM 3,300 RPM 3,500 RPM
	Baffle part number	47397652		51530439 51530439 51530439
2150 12/16-row	Bulk fan speed	3,200 RPM		Not validated for this configuration
	Baffle part number	47397652		
2150 24-row	Bulk fan speed	3,200 RPM		Not validated for this configuration
	Baffle part number	47397656		
2160 32-row, 36-row	Bulk fan speed	2,500 RPM		3,100 RPM 2,400 RPM 3,000 RPM
	Baffle part number	47397660		51570223 51570223 51570223
2160 24-row, 47-row	Bulk fan speed	Not validated for this configuration		3,100 RPM 2,400 RPM 3,000 RPM
	Baffle part number			51570223 51570223 51570223

‡ The dark shaded background indicates components that are included in the Crop Kits.

* Large seed air baffles are factory installed in the inductor boxes of all 2100 series planters equipped with the bulk-fill option.

◇◇ If using the heavy duty air seal (part number 51479926), an additional 1 in H₂O – 5 in H₂O vacuum pressure may be required.

▲ If you experience very small seeds leaking out the bottom of the meter, consider adding 1-2 small (0.010 in) disk shims. Adding shims may increase vDrive® current draw and reduce stability, so only add shims as necessary. These shims should be removed when converting to other crops. Factory shimming on vSet® 2 is recommended in most circumstances for least current draw, stability, and best seed spacing performance.

• If within 200 seed/lb of the seed size range, test both of the discs

▲▲ When planting large, long seeds, the Hy Rate™ large seed tube may be required. The Large seed tube and Hy Rate™ sensor must be purchased separately from Service Parts. The large seed tube can be used with any seed type; however, seed placement in the trench and displayed seed spacing performance, including displayed population, may be less accurate with smaller seeds.

PEANUTS		POPCORN			CANOLA ▲	SORGHUM / MILO ▲	WHEAT / CEREAL RYE ▲
Small/medium	Large	Small	Medium	Large	All	All	All
500-1,400	200-600	1,500-4,800			75,000-180,000	12,000-19,000	
50 ■■	50 ■■						300 ■■

47931266‡	48186702‡				47818864‡	47818862‡	48186717‡
Peanut	Large peanut	Specialty	Specialty	Specialty	Canola	Large sugar beet	Wheat
32	29	27	27	27	80	32	164
0.230	0.250	0.115	0.115	0.125	0.047	0.086	0.07
47902636	48186707	73368279	73368279	73368280	47902738	73368267	4816718
Soybean ★★	NONE	Corn	Corn	Corn	Corn	Corn	Soybean
47852593 ★★	NONE	47779567	47779567	47779567	47779567	47779567	47852593
Large edible bean	Large edible bean	Specialty	Specialty	Specialty	Canola	Sugar beet	Wheat
47780004	47780004	47780001	47780001	47780001	48186694	47780005	48186724
Large seed upper brush	Large seed upper brush				Wiper Kit		Up Restrict Brush
47902637	47902637				47819357		47819349
4 ★	REMOVE	2	2	2	1	1	1-2
20-30	15-30	20	20	20	16-26	10-16	6-16
Yes ▲▲		Yes			No population monitoring	Yes	No population monitoring
No		No			No	No	No
No		No			No	No	No

Not validated for this configuration	Small seed	Canola	Small seed	Small seed
	3,500 RPM 47397656	Not validated for this configuration	3,200 RPM 47397656	Not validated for this configuration
	3,500 RPM 47397656	Not validated for this configuration	Pending 47397656	Not validated for this configuration
	3,500 RPM 47397652	2,000 RPM ♦ 90422271	3,200 RPM 47397652	3,400 RPM 47397652
	3,700 RPM 47397652	Not validated for this configuration	3,200 RPM 47397652	Not validated for this configuration
	3,700 RPM 47397656	Not validated for this configuration	3,200 RPM 47397656	Not validated for this configuration
	3,000 RPM 47397660	1,800 RPM ♦♦ 90419080	2,800 RPM 47397660	3,100 RPM 47397660
	Not validated for this configuration	1,800 RPM ♦♦ 90419080	Not validated for this configuration	3,100 RPM 47397660

‡ The dark shaded background indicates components that are included in the Crop Kits.
 * Large seed air baffles are factory installed in the inductor boxes of all 2100 series planters equipped with the bulk-fill option.
 ■■ Planting rate calculation: Row spacing (in.) X Population (seeds/acre) X Speed (mph) / 356,400 = seeds/second
 ★ For some seed sizes, it may be necessary to completely remove the baffle to prevent bridging.
 ★★ For optimal performance, you may need to remove the singulator when planting large long seeds.
 ▲ If you experience very small seeds leaking out the bottom of the meter, consider adding 1-2 small (0.010 in) disk shims. Adding shims may increase vDrive® current draw and reduce stability, so only add shims as necessary. These shims should be removed when converting to other crops. Factory shimming on vSet® 2 is recommended in most circumstances for least current draw, stability, and best seed spacing performance.
 ▲▲ When planting large, long seeds, the Hy Rate™ large seed tube may be required. The Large seed tube and Hy Rate™ sensor must be purchased separately from Service Parts. The large seed tube can be used with any seed type; however, seed placement in the trench and displayed seed spacing performance, including displayed population, may be less accurate with smaller seeds.
 ♦ Requires the canola conversion kit for 8-port inductor boxes.
 ♦♦ Requires the canola conversion kit for 18-port inductor boxes.

Case IH Planter Productivity Guide

ADJUSTMENTS

BLANK SEED DISK FOR SPECIALTY CROPS

A seed disk without holes is available from service parts for creating custom seed disks for specialty crops.

Item	Description	Part number
1	Blank seed disk	51636626
2	Blank seed disk ejector	51636627

NOTE: The blank seed disks are available from service parts only. Order as many seed disks and ejectors (one of each per row) as required for your planter configuration.

NOTE: The corn singulator (part number 47779566) is recommended for use with the blank seed disk.

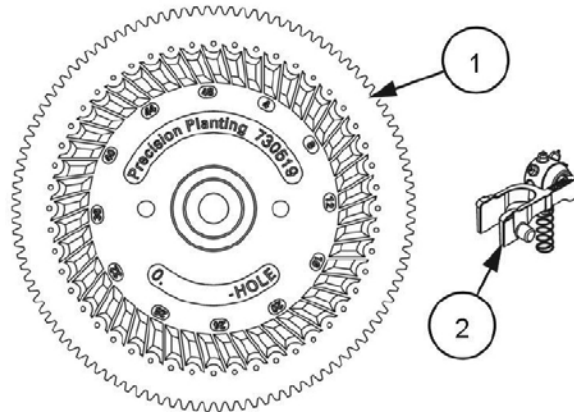

CUSTOMIZATION

Up to 48 holes may be drilled at a custom size for crops not covered by other available seed disks, or for custom low-rate planting applications. The blank seed disk has 48 dimples on the seed side for assistance in locating the position for drilling holes. There are 48 corresponding vacuum pockets on the opposite side of the disk. Therefore, the possible number of equally spaced custom drilled holes is: 1, 2, 3, 4, 6, 8, 12, 16, 24 or 48.

CALCULATION

Use the formula and the chart below to determine the quantity of holes to drill in the blank seed disk. Ensure the seed meter spins in the “recommended target RPM” range as much as possible.

The meter RPM can be calculated as follows:

United States Customary System (USCS) calculation:

$$\text{Seed Disk RPM} = \text{Row Width [inches]} \times \text{Population [seeds/acre]} \times \text{Speed [mph]} \div \text{Hole Count} \div 5940$$

International System of Units (SI) calculation:

$$\text{Seed Disk RPM} = \text{Row Width [centimeters]} \times \text{Population [seeds/hectare]} \times \text{Speed [kph]} \div \text{Hole Count} \div 60,000$$

NOTE: If required, refer to the “Seed Population/Spacing Chart” in the Operator’s Manual to determine the expected seed population for your application.

Recommendation	RPM	Comments
Minimum recommended RPM	8.7 RPM	The recommended minimum RPM helps keep the electric drive within stable operating range.
Maximum recommended RPM	130 RPM	The recommended maximum RPM helps keep the electric drive below its upper speed limit.
Recommended Target RPM	12-60 RPM	The target recommended RPM is highly dependent on seed size, shape, weight, seed surface characteristics, etc. Therefore, it is recommended to verify meter performance before planting.

ADJUSTMENTS

BLANK SEED DISK FOR SPECIALTY CROPS

HOW TO SELECT A BLANK SEED DISK EXAMPLE

1. Collect information for the following planting conditions for your application:
 - A. The lowest planting speed and the lowest population (1A).
 - B. The average planting speed and the average population (1B).
 - C. The highest planting speed and the highest population (1C).
2. Using one of the blank disk hole-count selections, calculate the seed disk RPM for the planting conditions (1A), (1B), (1C) to determine if the planting conditions remain within recommended seed disk RPM of 12 to 60 RPM.

NOTE: Use the average conditions calculation to help determine the best option in cases where the low and/or high calculations yield results that are marginal or slightly outside the recommended range.

Example 1:

NOTE: The following is an example of the blank disk hole-count selection not producing an acceptable seed disk RPM within the recommended range. Given the results, a different blank disk hole-count selection would be required.

- A. Condition **(1A)** (low speed, low population):
Seed disk RPM = $30 \text{ in} \times 10,000 \text{ seeds per } 1 \text{ acre} \times 3 \text{ mph} \div 24 \text{ holes} \div 5940$
Result: **6.3 RPM** (below recommended range)
- B. Condition **(1B)** (average speed, average population):
Seed disk RPM = $30 \text{ in} \times 14,000 \text{ seeds per } 1 \text{ acre} \times 4 \text{ mph} \div 24 \text{ holes} \div 5940$
Result: **11.8 RPM** (below recommended range)
- C. Condition **(1C)** (high speed, high population):
Seed disk RPM = $30 \text{ in} \times 16,000 \text{ seeds per } 1 \text{ acre} \times 5 \text{ mph} \div 24 \text{ holes} \div 5940$
Result: **16.8 RPM** (within recommended range)

Example 2:

NOTE: The following is an example of the blank disk hole-count selection producing an acceptable seed disk RPM within the recommended range. Given the results, this would be an acceptable selection.

- A. Condition **(1A)** (low speed, low population):
Seed disk RPM = $30 \text{ in} \times 10,000 \text{ seeds per } 1 \text{ acre} \times 3 \text{ mph} \div 12 \text{ holes} \div 5940$
Result: **12.6 RPM** (within recommended range)
- B. Condition **(1B)** (average speed, average population):
Seed disk RPM = $30 \text{ in} \times 14,000 \text{ seeds per } 1 \text{ acre} \times 4 \text{ mph} \div 12 \text{ holes} \div 5940$
Result: **23.6 RPM** (within recommended range)
- C. Condition **(1C)** (high speed, high population):
Seed disk RPM = $30 \text{ in} \times 16,000 \text{ seeds per } 1 \text{ acre} \times 5 \text{ mph} \div 12 \text{ holes} \div 5940$
Result: **33.6 RPM** (within recommended range)

Case IH Planter Productivity Guide

ADJUSTMENTS

DOWN PRESSURE ADJUSTMENT

Both pneumatic down pressure and DeltaForce® Hydraulic Down Pressure are controlled with the AFS Pro 700.

PNEUMATIC DOWN PRESSURE (PDP) ADJUSTMENT (IF EQUIPPED)

- 1) Add “PDP” window to run screen
- 2) Set target down pressure through “PDP Control” window

NOTE: Any pressure adjustment is always in addition to the down pressure provided by the weight of the row unit assembly and the product in the hopper(s).

- Controlled by the air pressure contained in the air springs on each row unit



GAUGE WHEEL LOAD CELL FEEDBACK (IF EQUIPPED)

- Load cells in row unit depth control linkage provide feedback on load carried by gauge wheels, usable to set a proper downforce target
- Customize down force reading shown on run screen
 - Press the run screen window and use arrows to switch between average, high row, and low row

AIR PRESSURE	APPLIED DOWNFORCE (Planting Position)
10 psi (69 kPa)	30 lb. (133 N)
20 psi (138 kPa)	60 lb. (267 N)
30 psi (207 kPa)	110 lb. (489 N)
40 psi (276 kPa)	160 lb. (712 N)
50 psi (345 kPa)	210 lb. (934 N)
60 psi (414 kPa)	260 lb. (1 157 N)
70 psi (483 kPa)	320 lb. (1 423 N)
80 psi (552 kPa)	380 lb. (1 690 N)
90 psi (586 kPa)	400 lb. (1 779 N)

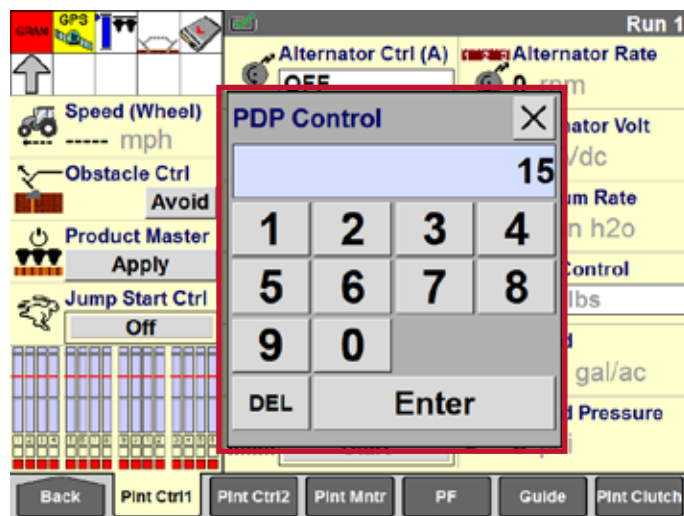
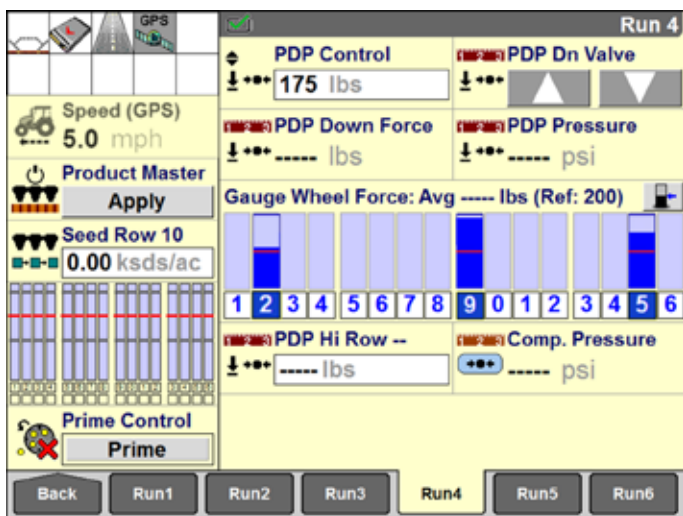

ADJUSTMENTS

DOWN PRESSURE ADJUSTMENT (continued)

DELTA FORCE® HYDRAULIC DOWN PRESSURE ADJUSTMENT (IF EQUIPPED)

- Use the “Down Force Control” window to set the target down force across the entire planter
 - Automatically controls row unit downforce and lift force by row to maintain a target load on gauge wheels
- Choose down force setting from pre-set options

SETTING	GAUGE WHEEL LOAD
Light	50 lb. (23 kg)
Standard	100 lb. (45 kg)
Heavy	150 lb. (68 kg)
Custom	0-650 lb. (0-294 kg)

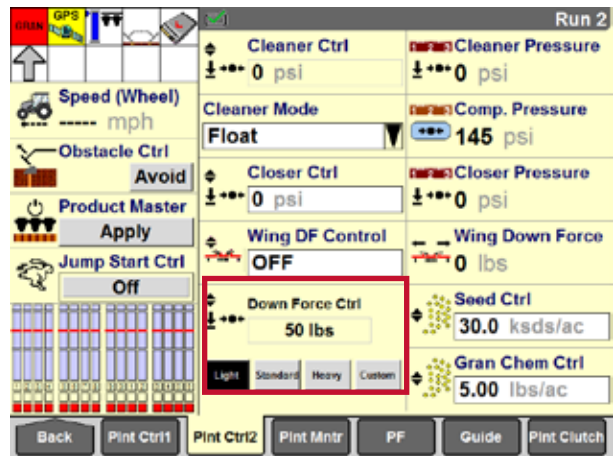
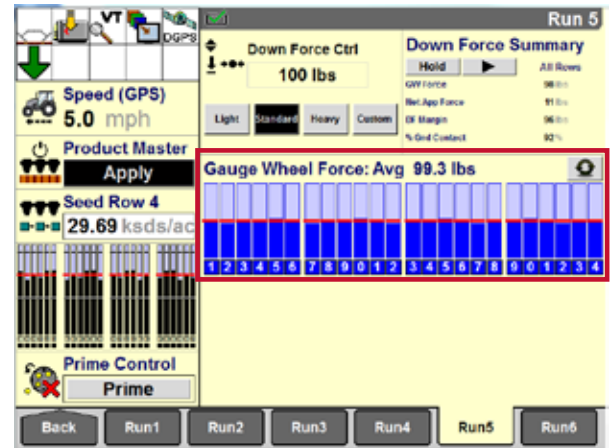

WING DOWNFORCE (IF EQUIPPED)

- Provides additional weight to planter wings, which is used for reactionary load against higher levels of row unit down force.
- Set through AFS Pro 700 display to target based on the applied row unit downforce
 - INFO** chart provided within Wing DF Control window
- System maintains desired wing downforce while in plant position (below “Start Plant”)
- Wing downforce removed when planter is raised (above “Stop Plant”)

Note: The target setting is a vertical load applied to each wing at the wing wheel position.

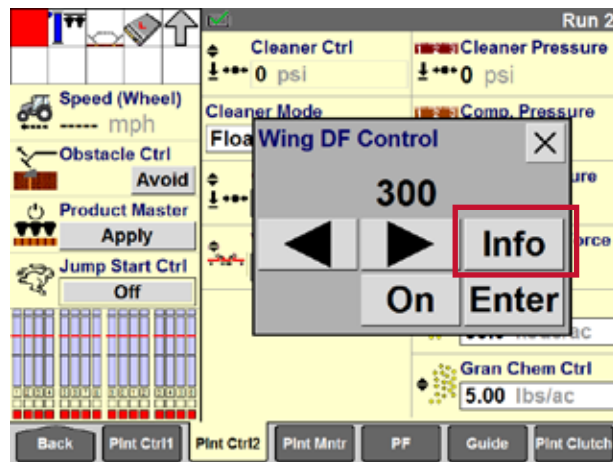

Case IH Planter Productivity Guide

ADJUSTMENTS

BULK FILL HOPPER FILLING AND FAN ADJUSTMENT (IF EQUIPPED)

1. Open bulk fill hopper lid and fill hopper with seed.
2. Add seed flow lubricant as prescribed on pg. 19, with each hopper fill.
3. Close lid before operation.
4. Use the AFS Pro 700 controls to set bulk fill fan speed for seed type being planted. Refer to the recommended settings chart on pg. 22-25.
5. Engage remote valve to supply hydraulic flow to the bulk fill fan.
6. Turn bulk fill fan on, and verify that system is delivering seed to the mini-hoppers. Allow mini hoppers to fill to the bottom of the hopper's seed decelerator (snorkel).

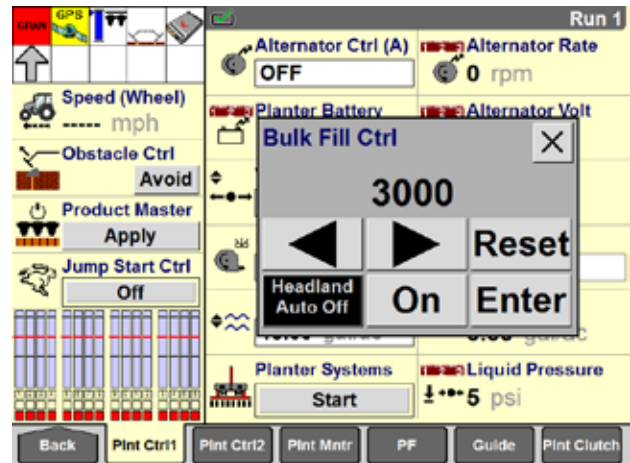

ON-ROW UNIT HOPPER FILLING (IF EQUIPPED)

1. Remove hopper cover and place it on the hopper edge.
2. Fill hopper with seed. Add seed flow lubricant as prescribed on pg. 19, both initially, and every time hopper is filled.
3. Secure hopper lid on hopper.

VACUUM ADJUSTMENT

Vacuum fans automatically regulate vacuum level to a target specified by the operator. Vacuum levels can be set to automatically compensate (speed adjusted vacuum) for increased ground speed to maintain seed meter performance.

- **Set tractor flow control or PTO control** to provide sufficient hydraulic flow to maintain vacuum level at desired planting speed. Refer to your Operator's Manual and Recommended Settings chart on pg. 22-25 for further instructions.
- **Use AFS Pro 700 to control vacuum default rate** by selecting Work Condition>Control>Controller>Vacuum. Then select "Default Rate" to use keypad to enter recommended setting for your crop type. Use "Delta Rate" and "Alarm Limit" to further control the vacuum operation. Refer to your Software Operation guide for more details.
- It is recommended to always have speed adjusted vacuum engaged so that your planter vacuum control will automatically compensate, for maximum meter performance, if your ground speed increases above 6 mph.

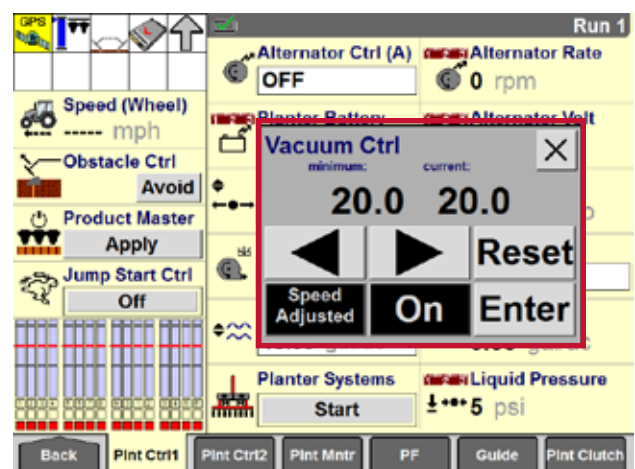

ADJUSTMENTS

ROW CLEANERS

- Residue managers should be adjusted to move residue only and not engage with the soil.
 - Recommend adjusting the depth stop pin to set the travel limit of the floating residue manager
- For air cylinder-equipped floating configurations, it is recommended to initially operate in the float setting.
 - If residue managers are too aggressive with the soil, a variable lift pressure can be applied to reduce the weight of the residue manager
 - If residue managers are not aggressive enough, a down pressure can be applied to add weight to the residue manager
 - Full lift mode can be utilized to automatically raise all residue managers

NOTE: Residue manager commanded movement will not take place until vacuum is started



DEPTH CONTROL

The depth adjustment on the row unit has been adjusted to zero at the factory. With all row units properly zeroed, seeds are placed at a uniform depth across all rows.

Check the zero setting when any of the following occur:

- New parts are installed on the gauge wheel and adjustment system
- Gauge wheel and arms are moved from one row unit to another
- Row unit not planting at same depth as another when set at the same setting
- During preseason preparation



Case IH Planter Productivity Guide

ADJUSTMENTS

PLANTING DEPTH ADJUSTMENTS

Before adjusting the planting depth or starting to plant:

- With the planter raised, ensure wobble bracket at the front of each row unit can move freely. This allows each gauge wheel to operate independently over uneven soil conditions to maintain uniform planting depth.

Planting depth is determined by the gauge wheels on each side of the staggered double disk openers on each row unit. The planting depth can be adjusted from 0-3.75 inches. Planting depth is adjusted with the control handle on the rear of each row unit. All row unit depth control systems have been zeroed from the factory to allow for consistent depth across all rows when in consistent setting. Example: Row 1, E5 setting = Row 2, E5 setting.

The depth adjustment scales on either side of the control handle are marked with letters (A to H) and numbers (1 to 8). **Note:** Always field verify depth after initial settings.

To adjust planting depth:

1. **Raise the row unit** to remove weight from the gauge wheels
2. **To adjust by 0.25 inch increments:**
 - Depress the handle and move to the desired position, while maintaining bevel orientation
 - Example: E5 is approximately 0.25 inches deeper than E4 (shown)
3. **To adjust by 0.125 inch increments:**
 - Rotate the depth adjustment handle
 - Deeper: Rotate 180 degrees within same slot to point bevel forward (shown)
 - Shallower: Rotate 180 degrees within same slot to point bevel rearward
3. **Repeat for all row units.** If a row unit is not planting at the same depth as another when set at the same setting, contact your dealer for information regarding row unit zeroing.

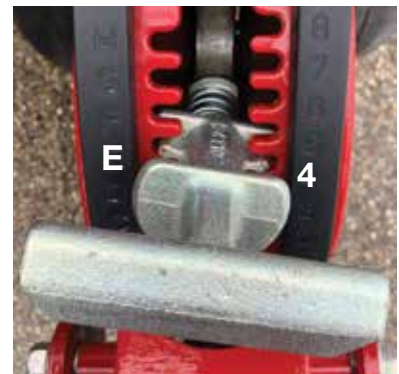

Bevel pointing forward.

Row Unit Depth Indicator

Left Side Letter	Right Side Number	Bevel Facing Closing	Bevel Facing Toolbar
A	1	0 in (0 mm)	0.125 in. (3.2 mm)
B	1	0.25 in (6.4 mm)	0.375 in. (9.5 mm)
B	2	0.5 in (12.8 mm)	0.625 in. (15.9 mm)
C	2	0.75 in (19.1 mm)	0.875 in. (22.2 mm)
C	3	1.0 in (25.4 mm)	1.125 in. (28.6 mm)
D	3	1.25 in (31.8 mm)	1.375 in. (34.9 mm)
D	4	1.5 in (38.1 mm)	1.625 in. (41.3 mm)
E	4	1.75 in (44.5 mm)	1.875 in. (47.6 mm)
E	5	2.0 in (50.8 mm)	2.125 in. (54.0 mm)
F	5	2.25 in (57.2 mm)	2.375 in. (60.3 mm)
F	6	2.5 in (63.5 mm)	2.625 in. (66.7 mm)
G	6	2.75 in (69.9 mm)	2.875 in. (73.0 mm)
G	7	3.0 in (76.2 mm)	3.125 in. (79.4 mm)
H	7	3.25 in (82.6 mm)	3.375 in. (85.7 mm)
H	8	3.5 in (88.9 mm)	3.625 in. (92.1 mm)

ADJUSTMENTS

CLOSING SYSTEM ADJUSTMENTS

TWO-STAGE CLOSING SYSTEM (IF EQUIPPED)

Closing Disk Adjustment

The closing disk down pressure can be adjusted as needed to operate in various soil conditions. Install the pin in one of the following locations as needed. Multiple positions are available for various soil types.

Positions shown at right:

- A** – Pneumatic cylinder (if equipped) for in-cab disk adjustment (all soil conditions)
- B** – Light spring downforce (if equipped)
- C** – Normal spring downforce (if equipped)
- D** – Heavy spring downforce (if equipped)

A travel stop pin prevents excessive closing disk depth. This prevents ‘plowing’ of closing disks in soft areas of the field and prevents damage to the air cylinder (if equipped).

- 2 adjustment positions
- Field test your soil conditions and planting depth

MAX. FORCES AT 2 IN. DEPTH	AIR	SPRING
2-Stage Closing Discs	150 lbs.	47 lbs

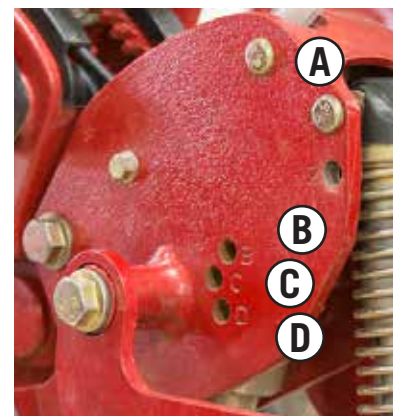

V-PRESS WHEEL CLOSING SYSTEM (IF EQUIPPED)

The V-Press Wheel Closing system can be equipped with manual (spring-loaded) or in-cab (pneumatic) down pressure.

The v-closing wheels are staggered to improve residue flow. Closing wheel shims can be relocated to adjust wheel spacing for shallow planting depths if required.

In-Cab Pneumatic

- Use the “Closer Control” window to set the target down pressure. Use the keypad to enter the target down pressure (0-75 PSI).

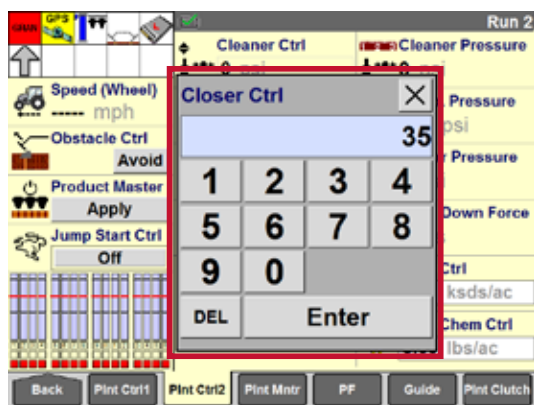

Manual (Spring-Loaded)

- Four pressure settings (shown) range from lightest (A) to heaviest (D) pressure

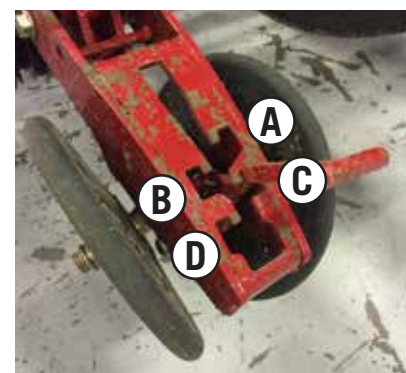

CONVERSION BETWEEN 2-STAGE AND V-PRESS WHEEL CLOSING SYSTEMS

Due to the modular row unit design, only 3 bolts need to be removed to convert between 2-Stage and V-Press Wheel Closing Systems.

MAX. FORCES AT 2 IN. DEPTH	AIR	SPRING
V-Press Wheel	135 lbs.	110 lbs.

Case IH Planter Productivity Guide

ADJUSTMENTS

CLOSING SYSTEM ADJUSTMENTS (continued)

Press Wheel Adjustment

The press wheel spring can be adjusted to operate in various soil conditions by installing the upper spring pin in the proper position.

- 1 – Light press wheel force
- 2 – Heavy press wheel force

MAX. FORCES AT 2 IN. DEPTH	AIR	SPRING
2-Stage Press Wheel	N/A	40 lbs.

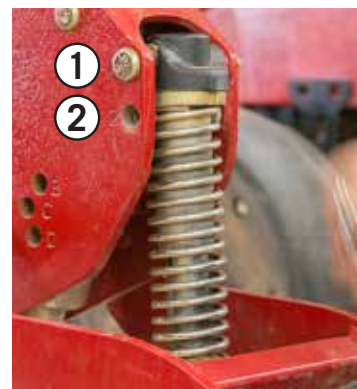

Additional Press Wheel Adjustments – Model Year 2021 & After

DUAL POSITION PRESSWHEEL ARM FORCES (LBS)									
SPRING		BLACK (1200 SERIES SPRING)				SILVER (2100 SERIES SPRING)			
Spring Perch/ Casting Position		1		2		1		2	
Wheel Position		Inner	Outer	Inner	Outer	Inner	Outer	Inner	Outer
Displacement	0 inch	34.2	26.5	58.4	48.1	41.0	35.0	52.8	43.1
	1 inch	41.5	31.8	64.2	50.7	42.7	36.5	53.5	45.3
	2 inch	47.3	35.8	70.8	56.3	45.7	39.0	55.5	46.6
	3 inch	54.4	41.1	76.9	60.4	49.4	41.0	57.3	48.7



LIQUID FERTILIZER

Liquid fertilizer application rates are controlled through the AFS Pro 700. Select **Liquid Ctrl** through a run screen to adjust the gal/ac rate.

Additionally, there are alternative windows available to monitor liquid flow in gallons per acre (gpa), gallons per minute (gpm), liquid system pressure and sectional control valve status.

Low pressure alarms during headland turns may require an increased Agitation percentage. This setting can be found under **Work Condition>Operate Tab**

Default setting is 35% and can be raised to increase liquid pressure in a headland turn

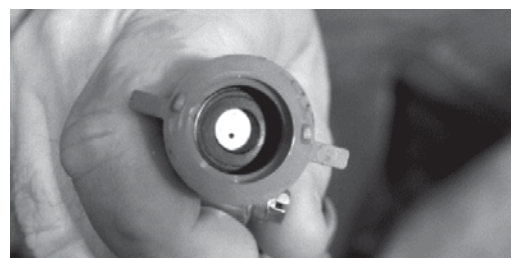

Common Orifice Part Numbers

- #29 86983914
- #35 86983916
- #40 86983918
- #52 86983919
- #65 86983920
- #89 86983921

Contact your Case IH dealer for more orifice options

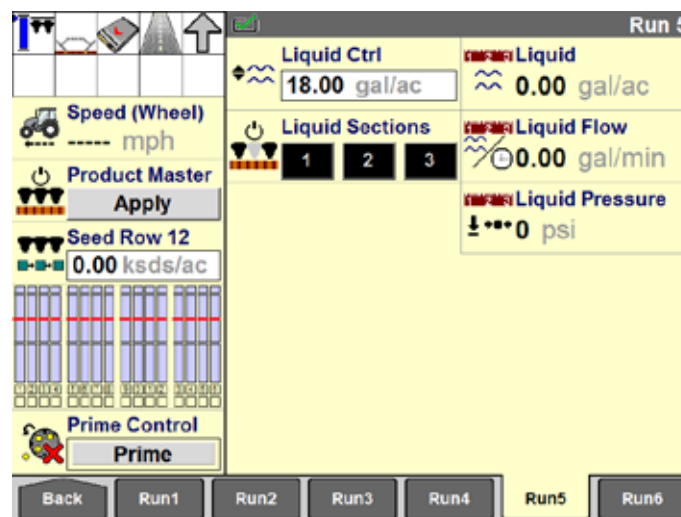
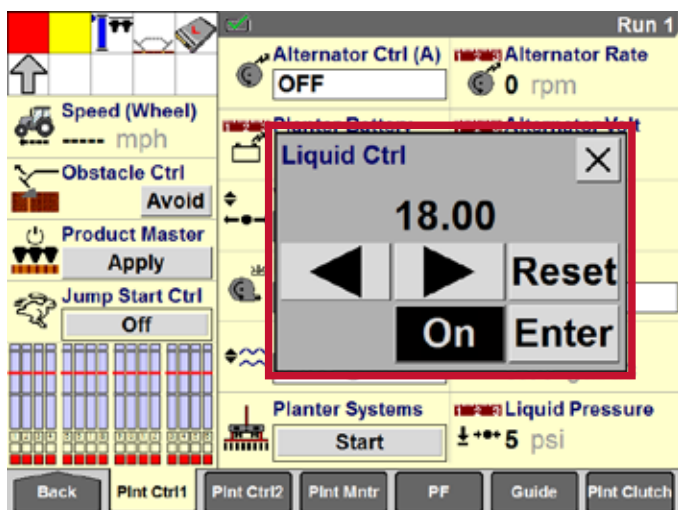

PLANTER OPTIONS

Shown are a few factory-supplied, dealer-installed attachments to upgrade your planter. For a full list of options, see your local Case IH dealer.



SpeedTube Upgrade (can upgrade one row, some rows, or all rows)



Individual Row Fertilizer Control



HD Mapping with Climate FieldView



Track System Upgrade (2140 & 2160 only)



Liquid Fertilizer Systems/Components (including kits for Split-Row 2140 and 2160)

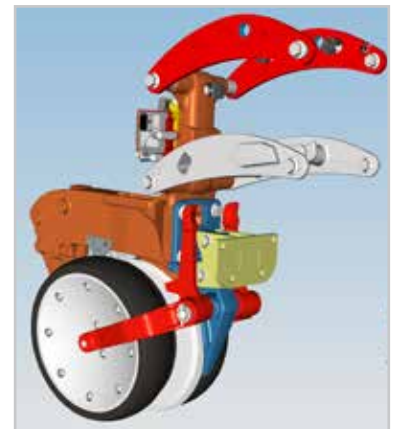

Plate Mount Tillage Adapter



Internal Mud Scrapers



2x2 Frame-Mounted Liquid Fertilizer for 2150



Martin-Till Unit Mounted Opener for 2x2 Liquid Fertilizer with Floating Residue Manager (2150 only)

Case IH Planter Productivity Guide

PLANTER OPTIONS

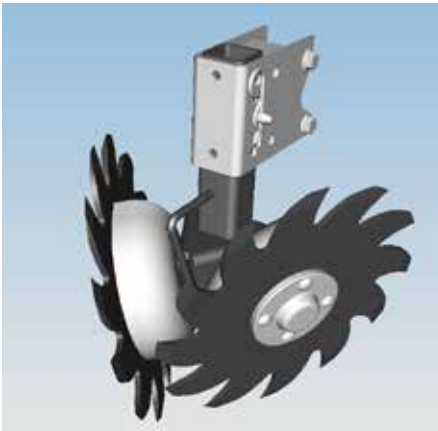

Fixed Tine-Wheel or No-Till Residue Managers



Floating No-Till Residue Managers with Depth Band (with or without air cylinder)

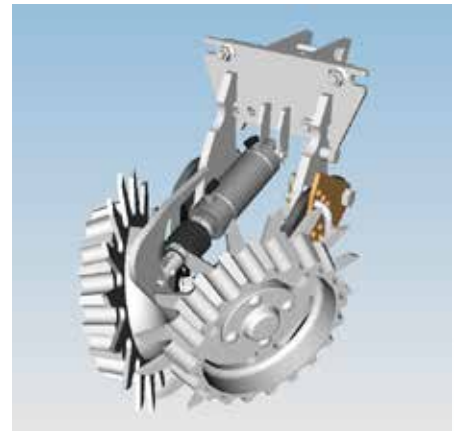

Floating Tine-Wheel Residue Managers (with or without air cylinder)



Row Unit Coulter

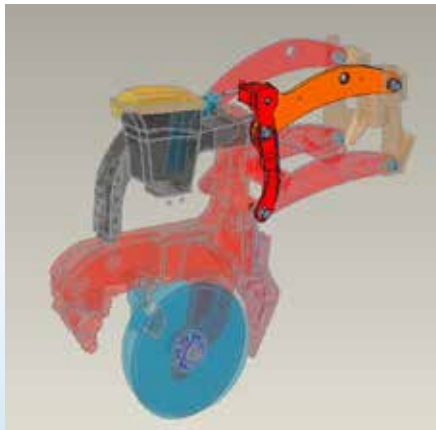

Row unit mechanical lock up for skip row planting patterns (2130 & 2150 Bulk Fill Only)

Other frequently purchased upgrades and accessories:

- Wheel Speed Sensor Kit
- Offset Hitch for 2140
- Even Row Conversion kit for 2140
- 2140 Marker Completion Kit for 2140
- 2140 Casting Wing Wheels



PLANTER OPTIONS

BULK-FILL SCALE



Bulk-Fill Weigh Scale for Monitoring Seed Tank Level



Case IH Planter Productivity Guide

PRECISION FARMING OPTIONS

FULLY INTEGRATED TECHNOLOGY FOR EASIER OPERATION AND MAXIMUM EFFICIENCY



Case IH Advanced Farming Systems (AFS) and AFS Connect deliver an integrated precision farming solution that gives you more control over every operation than ever before.

AFS PRO 700

AFS Pro 700 control center is the common interface across all platforms of Case IH equipment, for simplified operation across various machines.



Key Features include:

- Single, integrated color touch screen display
- Monitor and control integrated Precision Planting component
- Monitor and control Case IH vehicles and implements
- Record important data and maps to use for future management decisions
- Operates six run screens that allow you to configure what you want to monitor and/or control
- Provides three video inputs to: monitor implements and seed tank level, ease vehicle back-up and increase safety
- Adjusts screen brightness for night visibility

ADVANCED SEED INFORMATION™ (ASI™)

Advanced Seed Information (ASI) option gives you detailed seed placement information, which monitors seed for planting performance feedback.

Key Features include:

- Shows readings for singulation, skips, multiples, Seed Release Index (SRI), and good spacing
- User sets row readings – set for all rows, high row, low row, or average

AFS CONNECT

AFS Connect allows for 2-way file transfer for easy sharing of planter data between your home computer and a trusted adviser.



Key Features include:

- Cellular RTK guidance (NTRIP)
- Fleet management
- Machine dashboard monitoring
- Vehicle and/or implement data monitoring
- 2-Way file transfer
- Graphic reports
- Custom alerts

PLANTER PERFORMANCE MAPPING

Planter performance metrics, including Advanced Seed Information (ASI), down force, alternator metrics, and others, are visible through the Pro 700 and Desktop Software. For full capabilities of the Pro 700 and Desktop Software, refer to pg. 39.

PRECISION FARMING OPTIONS (CONTINUED)



AFS PRO 1200

New for Spring 2021 the Case IH AFS Connect Magnum™ & Steiger® lineup of tractors with the AFS Pro 1200 display now feature full ISO Planter Control.

The AFS Pro 1200 is a 12-inch LCD display featuring the Vision Pro Operating system allows the operator the freedom to customize the tractor to their operating preferences.

Key Features include:

- 6 customizable run screens featuring “widgets”
- Dedicated ISO run screen (Total of 7 Run Screens)
- High definition mapping capabilities
- Improved coverage logging functionality
- Split screen capabilities
- Remote display viewing (Tractor Data Only)
- Remote Service Tool & Firmware Over the Air

ISO Functionality for the 2000 Series Planters also enables other manufacturer's ISO capable displays to operate the planter. See your Case IH dealer for further details and display compatibility.



Case IH Planter Productivity Guide

MONITORS AND DISPLAYS



MONITORS AND DISPLAYS

	Numeric value visible within AFS Pro 700	Map visible within AFS Pro 700	Map visible within Desktop Software
Planter Data Type			
Seed			
Target Rate	•		•
Measured Rate (Population)	•	•	•
ASI			
% singulation	•	•	•
% skips	•	•	•
% multiples	•	•	•
Seed Release Index (SRI)	•	•	•
% good spacing	•		
Liquid			
Target Rate	•		•
Measured Rate	•	•	•
Measured Flow	•		
Measured Pressure	•		
Granular			
Target Rate	•		•
Measured Rate	•	•	•
Hydraulic Down Force			
Target Down Force	•		
Measured Down Force	•		•
Net Applied Down Force	•		•
% Ground Contact	•		•
% Good Ride			•
Pneumatic Down Force			
Target Down Force	•		
Measured Down Force	•		
Measured Pressure	•		
Gauge Wheel Down Force	•		
% Ground Contact	•		
Pneumatic Cleaner			
Target Pressure	•		
Measured Pressure	•		
Pneumatic Closer			
Target Pressure	•		
Measured Pressure	•		
Compressor			
Tank Pressure	•		
Wing Down Force			
Target Down Force	•		
Measured Down Force	•		
Measured Pressure	•		
Alternator			
Target Rate (RPM)	•		
Measured Rate (RPM)	•		
Measured Voltage	•		
Planter Battery Voltage	•		
Large/Medium Tractor (Trip Computer) Data Type			
Wheel slip	•		•
Engine load	•		•
Engine power			•
Engine speed	•		•
Fuel economy	•	•	•
Fuel used	•		•
Speed	•		•
General Precision Farming Data Type			
Elevation (altitude)	•		•
PDOP	•		
HDOP	•		
GPS quality (signal type)	•		•
Heading	•		•

Note: Case IH Early Riser series planters are not compatible with ISO11783 displays.
All AFS 2000 series planters must be operated with the AFS Pro 700 display.

Case IH Planter Productivity Guide

MONITORS AND DISPLAYS

AFS PRO 700 DISPLAY

INTRODUCTION

The AFS Pro 700 display from Case IH AFS is an integral part of the operation of the 2000 series Early Riser series planters. AFS Pro 700 display controls numerous planter operations and provides the operator with the ability to integrate a multitude of AFS Precision Farming features. GPS-driven planting and nutrition prescriptions can be used to fine-tune inputs to maximize profitability. Row-by-row control through Overlap Control and Curve Compensation is similar to having individual planters along the toolbar delivering accuracy in all types of fields. Optional Advanced Seed Information (ASI) gives detailed seed placement information for utmost planting confidence.

Requirements:

- The display should always have a data card (P/N 84398840) installed before turning on the display. If no card is installed, any data recorded while the display has no data card will be lost.

GENERAL NAVIGATION

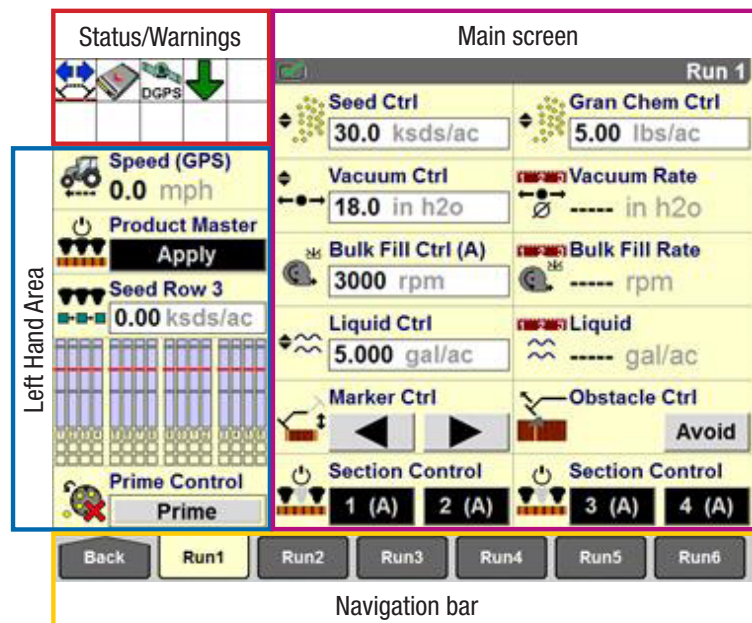

Main Screen



Toolbox – Display preferences and operator preferences, customizing run screens, GPS set-up, vehicle and implement set-up, etc.



Run – Access six customizable user screens for all applications.



Performance – View Summaries & Assign Prescriptions (Rx).

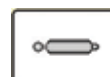

Remote Valve – Fold/Unfold & adjust remote valve flows, timers, locks.



Calibration – Radar, Area, Distance, Navigation, Frame, Row Unit Load Cells, and Turn Compensation Gyro Calibration.



Wizards – Step-by-step planter set-up.



Work Condition – Store a group of vehicle or implement settings that could be based on crop type, products, weather conditions, or field conditions.

SET-UP

There are two methods to performing seasonal and day-to-day settings

1. Using Wizards (Recommended - Guides the user step-by-step through set-up)
2. Selecting each screen separately to set-up

AFS PRO 700 DISPLAY (continued)

WIZARDS

The “Full Setup” wizard provides a guided, step-by-step process for setting up the current planter with a focus on the operator’s specific operating requirements. The wizard greatly reduces the time and effort associated with planter setup by prompting the operator for information that would otherwise require navigating to numerous setup screens independently.

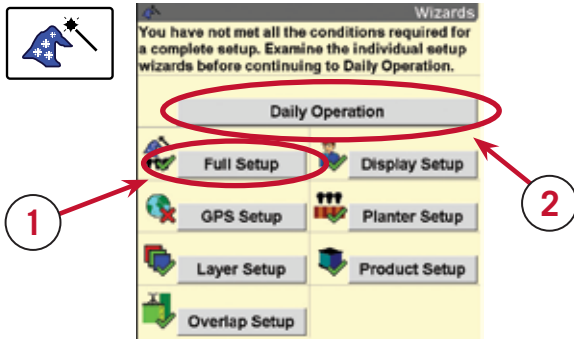

1. Select Wizards Button on Main/Home Screen (Back>Wizards).
2. Select “Full Setup” (1) to begin set-up process for the first time or if a crop type has been changed.
3. Adjustments after first time full set-up is completed can be done by selecting the other set-up buttons available on the ‘Main’ screen (GPS Setup, etc.).
4. Utilize the Daily Operation Wizard (2) to begin work each day (Fold, Unfold, begin planting & check basic set-up).

RUN SCREEN LAYOUT

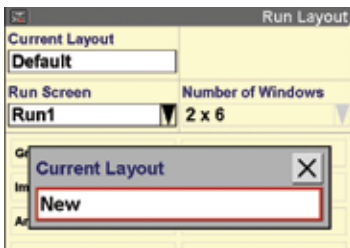

Toolbox > Layout

Adjust Run Screen Layout – Toolbox > Layout.

Create your own customized layout. Everyone on the farm can have their own layout, if desired.

GPS SET-UP

Note: The following steps are also found in the Wizard based set-up.

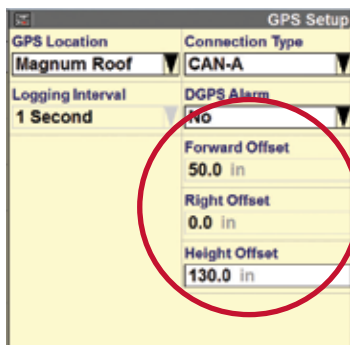

Toolbox>GPS>Forward Offset/Right Offset/Height Offset

Measure/Check reference Point on Tractor – Verify GPS receiver position.

- MFWD - Rear Axle
- 4WD – Front Axle

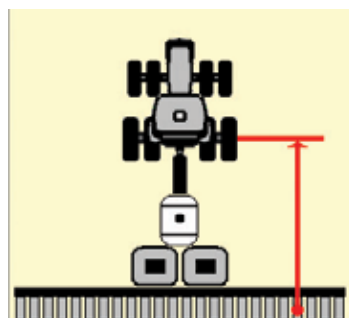

Toolbox>Config

Bar Distance – Position of Planter must be measured in relationship to a reference point on the tractor.

Do not adjust Bar Distance to adjust Overlap Control – Adjust Product Delay

Case IH Planter Productivity Guide

MONITORS AND DISPLAYS

AFS PRO 700 DISPLAY (continued)

AS-APPLIED MAPPING & VARIETY TRACKING

Note: The following steps are also found in the Wizard based set-up.

Product Setup	
Product Name	Form
BRANDX	Seed
Crop	
Corn	
Default App Rate	Delta App Rate
34.0 kds/ac Units	1.0 kds/ac
Min App Rate	Max App Rate
0.0 kds/ac	34.0 kds/ac
Package Size	RX Scale Factor
56.00 lb Units	1 : 1.0000
Product Density	Unit Density
0.00 lb/gal Units	1428.57 sds/l Units



(Toolbox>Product)

1. Create a Product (Variety or Fertilizer, etc) Note: Products can be created and exported using AFS software



(Work Condition>Layer)

2. Create a Work Condition, if needed (ex. Corn Planting)
3. Choose layer type (Seed, Seed Left, Seed Right, Liquid, etc.); Seed Left/Seed Right for split hybrid planting
4. Assign the Product to a Mapping Layer.
5. Assign additional products
6. Change the Product when changing the seed variety being planted.

Work Condition	
CORN-HIGH POPUL	
Layer 1	
Seed	
Product 1	Container 1
BRANDX	None
Layer 2	
Liquid	
Product 2	Container 2
10-34-0	None

PRESCRIPTION ASSIGNMENT

Prescription Setup	
Auto Reload Rx	Grower
Enabled	Case IH Farms
Farm	Field
Hempen Farm	North Field
Layer 1	
Seed	
Product 1	Product 1
E1602SS	
Prescription 1	Out Of Zone Rate 1
HEMPENS - Seed	34.0 kds/ac
Layer 2	
No Control	
Product 2	Product 2
Prescription 2	Out Of Zone Rate 2

1

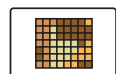

(Performance>Rx Setup)

1. Select Grower>Farm>Field
2. Assign Prescription (1) (If Prescription is not available verify Grower>Farm>Field and/or the prescription was exported properly (AFS Pro 700 requires Voyager 2 and shapefile formats only!)

Run 2	
Cleaner Ctrl	Cleaner Pressure
0 psi	0 psi
Cleaner Mode	Comp. Pressure
Seed Ctrl	
30.0	
Reset	
On Enter	
Gran Chem Ctrl	
5.00 lbs/ac	

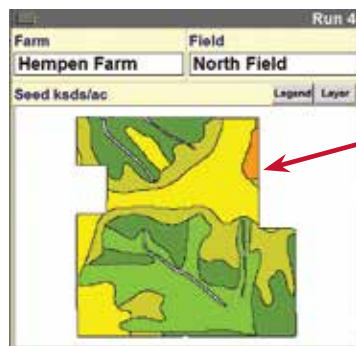

2

3. Verify 'Out of Prescription Zone Rate'
4. Prescription map (2) is available on the Run Screen Map (Note: Adjustment to the Legend and Layer menus may be needed to view zones)
5. Prescription is active during planting if (A) is next to 'Seed Ctrl' on the Run Screen.
6. Press 'Auto' button to Grey for manual rate control if prescription control is not desired.

AFS PRO 700 DISPLAY (continued)

LIQUID CALIBRATION

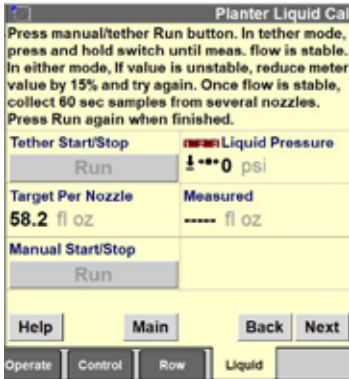

Work Condition > Liquid

Calibration of the Liquid Fertilizer system is critical for accurate application rates. Follow the steps in the Wizard for calibration. Tips for use:

1. Verify target application rate.
2. Verify target planting speed.
3. Start calibration procedure with default value listed in software (this will be 200 for the standard/low flow meter)
4. Press either the Tether run start/stop button to run the motor and pump remotely via the tether switch or press the manual run Start/stop button to run the motor and pump from the cab.
5. After flow stabilizes, place measuring container under the fertilizer tubes of 1 row per section.
6. Collect a 1-2 minute sample from each row and then turn off the system by tether switch or manual run button.
7. (Liquid Only) Average the samples taken from each row and enter in actual flow measured amount to adjust calibration value.

FRAME CALIBRATION

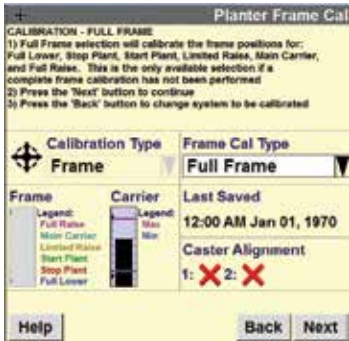

Calibration>Sensors>Frame Cal Type

Frame Calibration is critical for proper operation.

Calibrate each height position by raising or lowering planter to desired position and press 'Cal'. Individual positions can be recalibration at a later time, by selecting 'Frame Cal Type'

Note: On 2160 units, rows equipped with row unit lift must be raised prior to performing complete frame calibration.

SPEED/DISTANCE CALIBRATION

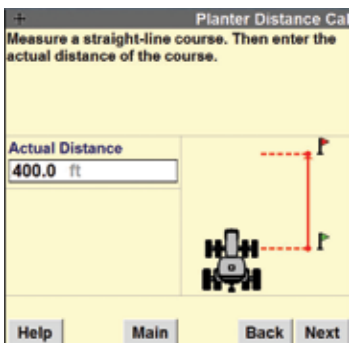

Calibration>Distance

The Speed/Distance Calibration calibrates the planter speed (wheel) sensors and is critical for applying/recording proper application rates and acres. Follow the steps in the Wizard for calibration.

Note: Needed for units with wheel speed sensors only.

Some helpful tips:

1. Perform with Seed Tanks ½ full & in field conditions
2. Mark out course at least 400 ft long.
3. Press start button at start of course.
4. Press stop button at end of course.
5. Press 'Cal'.
6. Repeat 4 times, average the Cal numbers and manually enter the Cal #.

Case IH Planter Productivity Guide

MONITORS AND DISPLAYS

AFS PRO 700 DISPLAY (continued)

GRANULAR CHEMICAL CALIBRATION



Work Condition > Gran

Note: AMVAC provides free calibration service. Contact 888-762-7826 for assistance.

Each granular product meter in the AMVAC SmartBox® system can store one calibration value at a time. Use the “Granular Chemical Calibration” screen to perform a catch test and update the stored calibration values as required.

1. Press “Work Condition” to create or select a work condition
2. Press “New product name” for meters with no previous calibration for the specific product. Otherwise, press “Next.”
3. Enter intended application rate, distance for simulation, and simulation speed.
4. Use “Starting with Row” window and “Ending with Row” window to select meters for calibration.
5. Press “Run” to ready system for calibration.
6. For each granular product drive, weigh components of catch bottle, use arrows to select row of sample collection, and enter measured weight in “Actual” window.
7. After calibration value is displayed, press “Next” to complete.

ROW UNIT LOAD CELL CALIBRATION

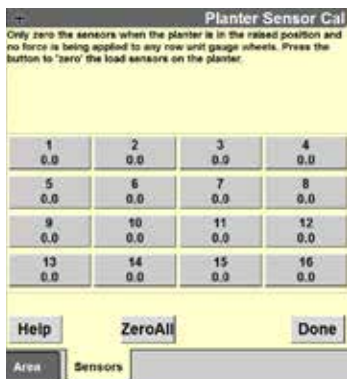

Calibration>Sensors

1. Raise planter above limited raise height so no force is applied to gauge wheels.
2. Press “Calibration Type” window to access options window.
3. Press “Row Unit Load Cells” to select load cell calibration.
4. Press row number buttons to calibrate individual row unit cells or press “Zero All” button to calibrate all load cells, then press “Done” to complete.

TURN COMPENSATING GYRO CALIBRATION



Calibration>Sensors

Note: Planter cannot be moving for correct calibration.

1. Unfold planter, and lower to height typical of in-field turns.
2. Press “Calibration Type” window, then press “Turn Compensation Gyro.”
3. Press “Zero” button to begin, then press “Done” to complete.

AFS PRO 700 DISPLAY (continued)

GROUND SPEED SELECTION

Ground speed source selection is available in v30.* and after Large Tractor (Magnum 250 & larger and Steiger) software. The sources available will be listed and can be chosen as a ground speed source by any planter model. If the desired source is not available it is likely that source is either not turned on or available at that time.

Note: The planter drives will not turn while traveling at under 1 mph.

LARGE TRACTOR SOFTWARE



Toolbox>Speed>Speed Source
(available on a run screen as well)



- Tractor Wheel Speed



- Planter Wheel Speed (if available)



- Radar (if available)



- GPS (If available)

- Default Work Condition>Operate>Speed Priority



Speed Source Selection (GPS not shown)



Note! The tractor wheel speed sensors must always be available/valid, no matter the Speed Priority. If no tractor wheel speed sensor is available, no planting will occur. Tractor wheel speed is used when traveling one (1) mph or under.

MEDIUM TRACTOR SOFTWARE

(Puma, Magnum 180-240 & Optum)



Toolbox>Speed>Speed Source

- Tractor Wheel Speed



- Planter Wheel Speed (if available)



- Radar (if available)



- GPS (If available)



- Default Work Condition>Operate>Speed Priority

Note! The tractor wheel speed sensors must always be available/valid, no matter the Speed Priority. If no tractor wheel speed sensor is available, no planting will occur. Tractor wheel speed is used when traveling one (1) mph or under.

If Default is chosen, the 2150 and 2160 planters have an option to choose different ground speed priorities. Use Toolbox>Speed to choose the speed source



Work Condition>Operate

Priority if “Planter/Tractor” selected, the software uses speed sources in this order of priority:

1. Planter or Tractor Wheel speed sensors if input is valid
2. Tractor radar if input is valid
3. GPS speed if input is valid

Priority if “Tractor/Planter” selected:

1. Tractor radar if input is valid
2. GPS speed if input is valid
3. Planter or Tractor Wheel speed if input is valid

GENERIC TRACTOR SOFTWARE

(Prior to 2006 MX Magnum or STX Steiger & Competitive Tractors)

- Utilizes Speed Priority Set in **Work Condition>Operate >Speed Priority**

Note! The planter wheel speed sensors must always be available/valid, no matter the Speed Priority. If no planter wheel speed sensors are available, no planting will occur. Planter wheel speed is used when traveling one (1) mph or under.

Case IH Planter Productivity Guide

MONITORS AND DISPLAYS

AFS PRO 700 DISPLAY (continued)

OVERLAP/BOUNDARY CONTROL SETTINGS (SECTIONS AND ROW CONTROL)

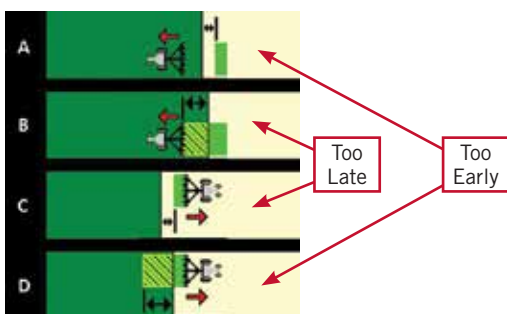
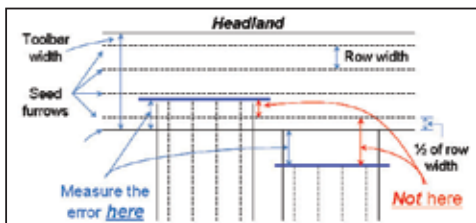

Recommended! All Boundary and Overlap Control settings can be adjusted and calculated using the Wizard. Information below is for reference.

Before making any adjustments to the Product Delay, make sure GPS offsets & Bar Distance, is entered correctly, Product are assigned to layer and a data card is in the display.

To check performance:

1. Test Overlap Performance at headland (keep a consistent speed!)
2. Measure the error (Distance between where seed SHOULD have been and where seed ACTUALLY is.)

Note! Final product delay adjustment should result in a gap from the first headland row (approx. 1/2 the row width)

3. Calculate the change in existing Product Delay (PD):

$$\text{change in PD (sec)} = \frac{\text{In. of error}}{\text{mph} \times 17.60}$$

(Work Condition>Control>Seed)

Too Early = DECREASE PD by calculated amount

Too Late = INCREASE PD by calculated amount

4. Once Product Delay is set, adjustments can now be made to the Start Early/Stop Late Distances (1) if intentional overlap is desired. (Toolbox>Overlap)

Note: Start Early/Stop Late does not affect Boundary Control. Adjust Product Delay.

WORK CONDITION

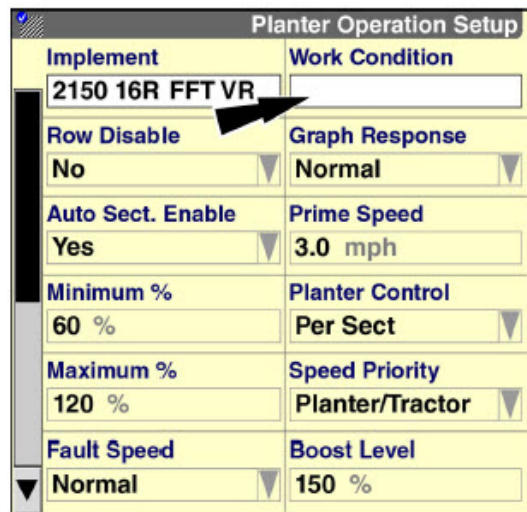

Quickly change multiple settings with one key based on planting condition.

- Change by crop type, product characteristics, weather conditions, or field conditions
- Includes all selections in windows on "Layer Assignment," "Planter Operation Setup," "Planter Calibration Setup," "Row Setup," and "Liquid Calibration," and all calibration values for selected products.
- Recommendation – start with a vague work condition name, and create new work conditions as needed.

AFS PRO 700 DISPLAY (continued)

AFS & ASI (ADVANCED SEED INFORMATION): UNLOCK REQUIRED

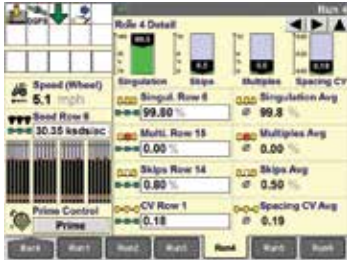

Note: ASI activation utilizes the same unlock code as AFS AccuStat. Code is transferable from one system to the other (P/N: 47464425 + Transfer P/N: 47464425T).



Toolbox>ASI

- Adjustable Color coded quality thresholds
 - Green = Good
 - Yellow = Average
 - Red = Poor



Troubleshooting Planter Performance

Refer to your Operator's Manual or your dealer for additional troubleshooting.

A **single row** is problematic:

- Singulator Adjustment/Failure
- Knockout Wheel/Failure
- Seed Disc Selection/Issue
- Seed Meter Baffle Setting
- Seed Meter Drive (vDrive)

An **entire section** is problematic:

- Hydraulic Component Issue/Failure
- Vacuum Distribution Issue

All rows/sections are problematic:

- Seed disc selection issue (ex. holes to close together and seed touching)
- Moist/sticky seed treatments
- Seed Flow Lubricant needed
- Incorrect Vacuum Level (use minimum setting)
- Residue manager settings (not plowing)
- Toolbar height (26 in.)
- Display settings (cells/disc setting)

EARLY RISER 2160 STEERABLE AXLE OPERATION (IF EQUIPPED)

The 2160 features a unique rear steering axle that allows the operator to control the position of the planter when turning a tight corner in transport mode only. The result is faster roading between fields and more time planting.

To use the rear steering axle:

- Assure Steering Axle Calibration has been performed (**Calibration>Sensors>Impl Steering>Last Saved**).

If it has not been calibrated or the axle is not centered after returning to center, use the calibration wizard to calibrate the steering axle (left/right/center positions).



Activate the steering axle by choosing:

Remote Valves>Planter Frame Operation>Steering and pressing **Manual**.

- Use the lift/lower/fold remote valve to steer the rear axle.
Note: The axle will be disabled above 9 mph.
- To recenter, activate the remote valve and press the **Reset** button.

Note: Auto-centering of the steering wheels or tracks will also take place when the planter is in "Plant" mode and the planter is raised at the headland turn.

Case IH Planter Productivity Guide

MONITORS AND DISPLAYS

RUN SCREEN LAYOUT EXAMPLES

Run screen layout examples shown below. Available functions will vary by planter configuration.

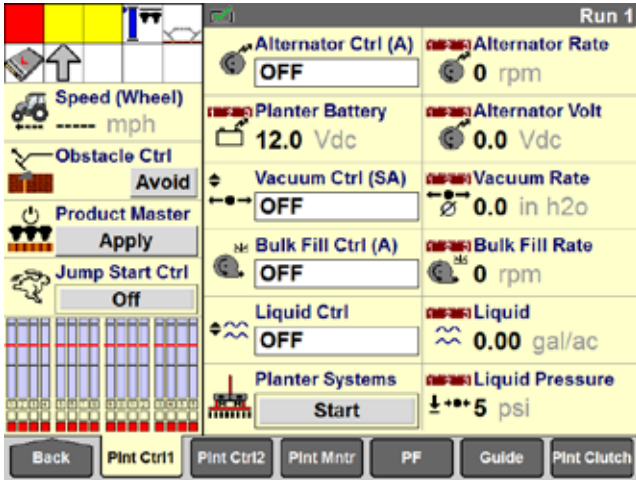

Run Screen 1

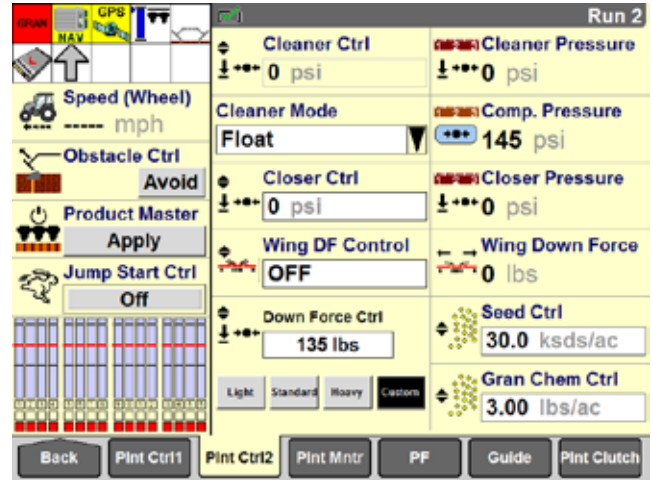

Run Screen 2

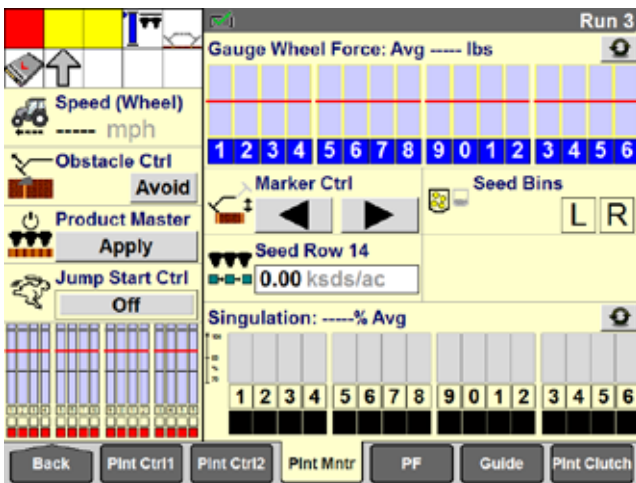

Run Screen 3

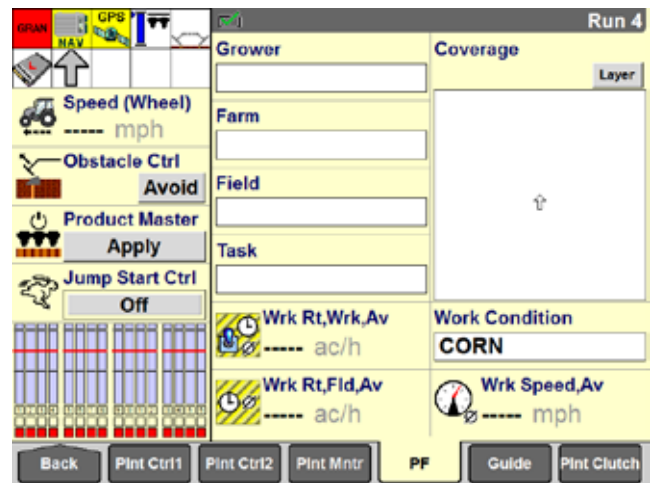

Run Screen 4

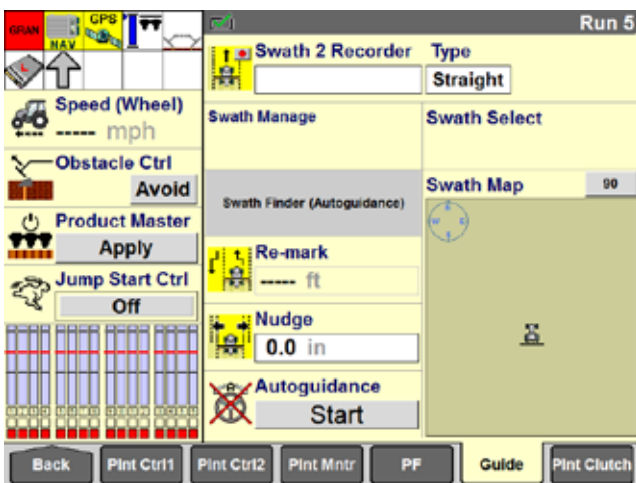

Run Screen 5

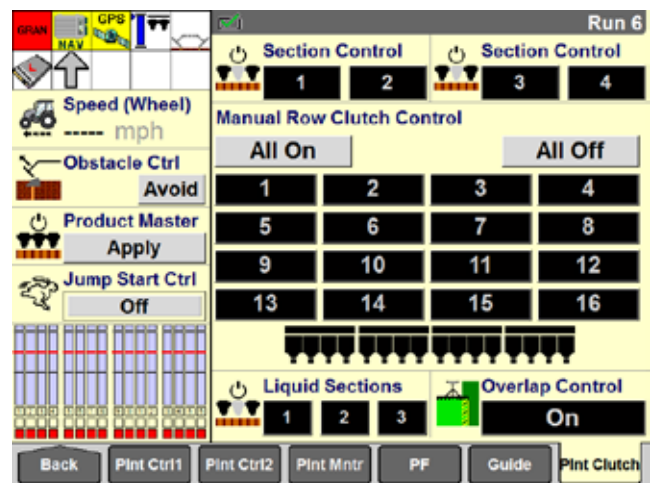

Run Screen 6

MONITORS AND DISPLAYS

ICON LEGEND

STATUS AND WARNING ICONS

Status icons

Icon	Meaning	Icon	Meaning
	A seed section is turned OFF.		A row seed sensor is faulty.
	The toolbar is in the fully raised position.		Distance calibration is in progress.
	A container level is low, or a container is empty.		A container event is in progress for filling, refilling, or flushing. Time, location, and fill amount are being recorded.
	A seed bin level is low.		A granular chemical bin level is low.
	No marker is deployed.		Both markers are deployed
	The left marker is deployed.		The right marker is deployed.
	The "Avoid" button or "Inner" button in the "Obstacle" window has been pressed to avoid an obstacle to a marker.		"As Applied" data logging is in progress.
	Automatic overlap control has turned product application OFF on one or more planter rows or sections.		A row clutch is in "Manual" control mode. Any row clutch in "Manual" mode will not respond to automatic overlap control.

Vehicle status icons

Icon	Meaning
	The implement is raised.
	Area control is turned OFF. No area, distance, or time information is accumulated for planting.
	Radar calibration is in progress.
	The implement is lowered.
	The planter is roading. Area, distance, and time information is accumulating for roading.
	Simulated speed is enabled.

Warning icons

Icon	Meaning	Icon	Meaning
	The planter Universal Control Module (UCM) is disabled.		The granular controller is disabled.
	A product controller – seed, fertilizer, etc. – is at maximum duty.		A product controller – seed, fertilizer, etc. – is at minimum duty.
	A vacuum controller fault is active		A seed controller fault is active.
	A bulk fill controller fault is active		A liquid fertilizer controller fault is active.
	An error (ERR) is present on the "Layer Assignment" screen or an "As Applied" application fault is active. Data logging is not possible until the problem is corrected.		Vacuum fan and/or bulk fill fans are driven by a PTO pump. Engage the PTO before turning fans ON.
	A high case drain pressure fault is active. All hydraulic motors are disabled by the case drain sensor. Check the tractor low pressure return connection. Check the normally closed pressure switch for proper function.		

Case IH Planter Productivity Guide

MONITORS AND DISPLAYS

“RUN LAYOUT” SCREEN WINDOW SELECTION

PLANTING WINDOWS

The following table provides a quick overview of the various planting windows to simplify window selection when customizing the left-hand area and “Run” screens on the “Run Layout” screen (Home > Toolbox > Layout). Refer to your 2000 series Software Operating Guide for further detail.

Placement label	“Run” screen window	Description
Alternator Control		Use this window to set the alternator speed or to enable the “Auto Headland” feature which turns the alternator hydraulic motor OFF at headlands to allow faster frame lifting.
Alternator Rate		This window reports the measured alternator speed in rpm.
Alternator Volt		This window reports the voltage being produced by the alternator.
Area		This window reports the accumulated acres or hectares planted for the current task.
Area, Total Field		This window reports the accumulated acres or hectares planted for the current field, operation, and instance.
Area Farm		This window reports the accumulated acres or hectares planted for the farm since the counter was last reset.
Area Field		This window reports the accumulated acres or hectares planted for the field since the counter was last reset.
Area Life		This window reports the accumulated acres or hectares planted since the counter was last reset. The counter should remain active as long as the display is in service.
Area Season		This window reports the accumulated acres or hectares planted for the season or since the counter was last reset.
Bins, Seed		This window reports when the product level is low in the on-row or bulk seed hoppers when the planter is equipped with two sensors.
		This window reports when the product level is low in the on-row seed hoppers when the planter is equipped with one sensor.
Boundary Control		Use this control window to temporarily turn boundary control OFF or ON.
Bulk Ctrl		This window controls the target fan speed used to deliver seed from the bulk hoppers to the minihoppers on the row units.
Bulk Fill Weight (Gross)		For planters that are equipped with bulk fill scales, this window reports the gross weight of the bulk fill tanks.
Bulk Fill Weight (Net)		For planters that are equipped with bulk fill scales, this window reports the net weight of the bulk fill tanks – the gross weight minus the tare weight.
Bulk Rate		This window reports the current speed of the bulk fill fan in rpm.
Cleaner Control		Use this window to control the pressure to the pneumatic cleaners when the “Cleaner Mode” window is set to “Lift” or “Down.”
Cleaner Mode		Use this window to select the operating mode of the cleaners: “Float,” “Lift,” “Down,” or “Full Lift.”

Placement label	“Run” screen window	Description
Cleaner Pressure		This window displays the measured pressure at the cleaners.
Cleaner Down Valve		The arrow icons in this window pulse to indicate the valves opening to reach and/or maintain the set down pressure for the pneumatic cleaners.
Cleaner Lift Valve		The arrow icons in this window pulse to indicate the valves opening to reach and/or maintain the set lift pressure for the pneumatic cleaners.
Closer Control		Use this window to control the pressure to the pneumatic closers.
Closer Down Valve		The arrow icons in this window pulse to indicate the valves opening to reach and/or maintain the set down pressure for the pneumatic closers.
Closer Pressure		This window displays the measured pressure at the closers.
Clutch Ctrl, Manual, 2x4		Use this 2x4 window to manually control the ON/OFF state of each row unit. The icons below the numbered buttons indicate the section and row unit ON/OFF state. NOTE: If a row is configured to be in an outer group on the “Planter Configuration Screen,” pressing the button for that row automatically toggles the ON/OFF state of all rows in the outer group.
Clutch Ctrl, Manual, 2x6		Use this 2x6 window to manually control the ON/OFF state of each row unit. The icons below the numbered buttons indicate the section and row unit ON/OFF state. NOTE: If a row is configured to be in an outer group on the “Planter Configuration Screen,” pressing the button for that row automatically toggles the ON/OFF state of all rows in the outer group.
Compressor Pressure		This window reports the total compressor pressure available to the software-controlled cleaner and closer systems in kPa or psi.
Down Force Bar Graph		This window displays a bar graph for each row on the planter to report three measurements of hydraulic down force performance: gauge wheel force, net applied force, and ground contact percentage.
Down Force Control		Use this window to select the operating mode of the hydraulic down force system. • “Light” - 22.7 kg (50.0 lb) • “Standard” - 45.4 kg (100.0 lb) • “Heavy” - 68.0 kg (150.0 lb) • “Custom” - Enter a custom value.
Down Force Summary		This window reports four measurements of hydraulic down force performance: gauge wheel force, net applied force, down force margin, and ground contact percentage.
Frame Control		This window controls planter frame operation (plant, fold, unfold and off), toolbar operation, and marker operation. The window duplicates the functionality of the “Frame Control” screen (Home > Remote Valves > Frame), but can be placed on the “Run” screens.
Granular Ctrl		This window controls the granular application rate for any variable drive planter using “All Section” planter control.
Granular Ctrl 1		This window controls the granular application rate for section 1 of any variable drive planter that is using “Per Section” planter control.

Placement label	"Run" screen window	Description
Granular Ctrl 1	Gran Chem Ctrl 1 4.50 lbs/ac	This window controls the granular application rate for section 1 of any variable drive planter that is using "Per Section" planter control.
Granular Ctrl 2	Gran Chem Ctrl 2 4.50 lbs/ac	This window controls the granular application rate for section 2 of any variable drive planter with two or more sections that is using "Per Section" planter control.
Granular Ctrl 3	Gran Chem Ctrl 3 4.50 lbs/ac	This window controls the granular application rate for section 3 of any variable drive planter with two or more sections that is using "Per Section" planter control.
Granular Ctrl 4	Gran Chem Ctrl 4 4.50 lbs/ac	This window controls the granular application rate for section 4 of any variable drive planter with two or more sections that is using "Per Section" planter control.
Granular Ctrl L	Gran Ctrl 1&2 4.50 lbs/ac	This window controls the granular application rate for the left side of any variable drive planter with four sections that is using "Per Side" planter control.
Granular Ctrl R	Gran Ctrl 3&4 4.50 lbs/ac	This window controls the granular application rate for the right side of any variable drive planter with four sections that is using "Per Side" planter control.
Implement Steer Angle	Implt Steer Angle	This window reports the angle of the implement steering wheels on a bar graph.
Jump Start Ctrl	Jump Start Ctrl Off	Use this control window to start product application when starting to plant from a stationary position. See 4-62.
Liquid	Liquid 18.00 gal/ac	This window reports the actual applied rate for liquid product.
Liquid Ctrl	Liquid Ctrl 18.00 gal/ac	This window controls the liquid fertilizer application rate.
Liquid Flow	Liquid Flow 5.16 gal/min	This window reports the flow of liquid product through the flow meter in terms of volume over time.
Liquid Pressure	Liquid Pressure 25 psi	This window reports the liquid application pressure from the liquid system pressure transducer.
Liquid Sections	Liquid Sections 1 (A) 2 (A) 3 (A)	This window controls all product application for liquid section 1 (left wing), section 2 (center), and section 3 (right wing). Liquid section control is completely independent of seed section control. If the planter has individual row nozzles, the liquid section valves will stay ON.
Marker Ctrl	Marker Ctrl (A)	In "Manual" mode, use this window to select the next marker to deploy when the planter toolbar is lowered. In "Automatic" mode, use this window to select the first marker to Deploy for automatic marker alternating. This window also reports the current mode of operation: (M) for "Manual" and (A) for "Automatic."
Markers	Markers Auto Man.	This window controls operation mode – "Automatic" or "Manual" – for the markers.
Master	Master Control Apply	This window controls all product application for the entire planter – seed, liquid fertilizer, and granular chemical.
Obstacle Ctrl	Obstacle Ctrl. Avoid	This window controls marker operation when avoiding a field obstacle.
Overlap Control	Overlap Control On	Use this control window to temporarily turn overlap control OFF or ON.
PDP Control	PDP Control 100 lbs	This window controls the set point for the software-based Pneumatic Down Pressure (PDP) system.
PDP Dn Valve	PDP Dn Valve	For planters that are equipped with the Pneumatic Down Pressure (PDP) system, the arrow icons in this window pulse to indicate the valves opening to reach and/or maintain the set down pressure.
PDP Down Force	PDP Down Force lbs	For planters that are equipped with the Pneumatic Down Pressure (PDP) system, this window reports the total down force achieved by the PDP system.

Placement label	"Run" screen window	Description
PDP Force Scan	PDP Hi Row 8 212 lbs PDP Lo Row 3 180 lbs GWF Force Avg 192 lbs	For planters that are equipped with the Pneumatic Down Pressure (PDP) system, this window reports the gauge wheel force on the high row (greatest force), the gauge wheel force on the low row (least force), and the average gauge wheel force across all rows that are equipped with load cells. NOTE: This window applies only to row units that are equipped with load cells.
PDP GW Force Graph 2x2	PDP GW Force Graph 2x2	For planters that are equipped with the Pneumatic Down Pressure (PDP) system, this window reports the gauge wheel force average for the entire planter and displays a graph of individual row unit performance. NOTE: This window applies only to row units that are equipped with load cells. An empty bar graph displays for any row unit that is not equipped with a load cell.
PDP Pressure	PDP Pressure psi	For planters that are equipped with the Pneumatic Down Pressure (PDP) system, this window reports the pneumatic pressure needed to achieve the set point in kPa or psi.
Planter Battery	Planter Battery 12.0 Vdc	This window reports the output voltage of the planter battery.
Planter Systems	Planter Systems Start	Once hydraulics are enabled, the "Start" button automatically turns on vacuum, bulk fill fan, product master, and primes the planter.
Prime Ctrl	Prime Control Prime	Use this control window to prime the seed meters and liquid fertilizer applicators, as equipped.
Row Scan	Seed Row 15 0.00 ksds/ac	This window reports the applied rate from each seed sensor, one row at a time, followed by the average applied rate (depending on the selected planter control).
Section 1 2	Section Control 1 2	This window controls all product application for section 1 and section 2 of the planter.
Section 3 4	Section Control 3 4	This window controls all product application for section 3 and section 4 of the planter.
Seed Ctrl	Seed Ctrl 30.0 ksds/ac	This window controls the seed application rate for any variable drive planter using "All Section" seed control.
Seed Ctrl 1	Seed Ctrl 1 30.0 ksds/ac	This window controls the seed application rate for section 1 of any variable drive planter with two or more sections that is using "Per Section" seed control.
Seed Ctrl 2	Seed Ctrl 2 30.0 ksds/ac	This window controls the seed application rate for section 2 of any variable drive planter with two or more sections that is using "Per Section" seed control.
Seed Ctrl 3	Seed Ctrl 3 30.0 ksds/ac	This window controls the seed application rate for section 3 of any variable drive planter with two or more sections that is using "Per Section" seed control.
Seed Ctrl 4	Seed Ctrl 4 30.0 ksds/ac	This window controls the seed application rate for section 4 of any variable drive planter with two or more sections that is using "Per Section" seed control.
Seed Ctrl L	Seed Ctrl 1&2 30.0 ksds/ac	This window controls the seed application rate for the left side of any variable drive planter with four sections that is using "Per Side" seed control.
Seed Ctrl R	Seed Ctrl 3&4 30.0 ksds/ac	This window controls the seed application rate for the right side of any variable drive planter with four sections that is using "Per Side" seed control.
Seed Graph 1 x 1	Seed Graph 1 x 1	This window displays a bar graph of current planting performance for each row unit relative to the target population rate in a one column by one row format.
Seed Graph 1 x 2	Seed Graph 1 x 2	This window displays a bar graph of current planting performance for each row unit relative to the target population rate in a one column by two row format.

Case IH Planter Productivity Guide

MONITORS AND DISPLAYS

“RUN LAYOUT” SCREEN WINDOW SELECTION (continued)

PLANTING WINDOWS

Placement label	“Run” screen window	Description
Seed Graph 2 x 2		This window displays a bar graph of current planting performance for each row unit relative to the target population rate in a two column by two row format.
Signal Watch, Planter		This window reports user selected signals for the planter frame and ECU's as set up on the "Planter Signal Monitoring" screen (Home > Diagnostics > Signals).
Spacing Scan		This window reports the spacing between seeds for each row unit, cycling through all rows one row at a time, and then reports averages.
Vacuum 1		This window reports the current vacuum rate for vacuum fan 1 in inches of H ₂ O.
Vacuum 2		This window reports the current vacuum rate for vacuum fan 2 in inches of H ₂ O.
Vacuum Ctrl		This window controls the target vacuum rate used for all vacuum fans on the planter to hold seed on the seed disks while planting.
Vacuum Rate		This window reports the current average vacuum rate for all fans on the planter in inches of H ₂ O.
Vacuum Scan		This window continuously reports the current average vacuum rate for vacuum fan 1, vacuum fan 2, and then the entire planter in inches of H ₂ O.
Wing Down Force		This window displays the calculated weight transferred to the wings by the wing down force system.
Wing DF Control		Use this window to set the amount of weight that the wing down force system transfers from the planter center to the wings.
Wing DF Pressure		This window reports the measured pressure to the wing down force system.

Placement label	“Run” screen window	Description
Work Light Ctrl		When a 2140 model planter is configured for bulk fill lights, this window controls the operation of the work lights. The highlighted button indicates the current mode of operation: <ul style="list-style-type: none"> When neither button is highlighted, work lights are OFF. When the "On" button is highlighted: <ul style="list-style-type: none"> Work lights are ON when the planter is not in transport position (toolbar height is less than 90% of the full raise height). Work lights are OFF when the planter is in transport position (toolbar height is greater than or equal to 90% of the full raise height). When the "Auto" button is highlighted: <ul style="list-style-type: none"> Work lights are ON when the planter is in "Plant" mode and ground speed is less than 1.6 km/h (1.0 mph). Work lights are OFF when the planter is in "Plant" mode and ground speed is greater than or equal to 1.6 km/h (1.0 mph).
Vacuum 2		This window reports the current vacuum rate for vacuum fan 2 in inches of H ₂ O.
Vacuum Ctrl		This window controls the target vacuum rate used for all vacuum fans on the planter to hold seed on the seed disks while planting.
Vacuum Rate		This window reports the current average vacuum rate for all fans on the planter in inches of H ₂ O.
Vacuum Scan		This window continuously reports the current average vacuum rate for vacuum fan 1, vacuum fan 2, and then the entire planter in inches of H ₂ O.
Wing Down Force		This window displays the calculated weight transferred to the wings by the wing down force system.
Wing DF Control		Use this window to set the amount of weight that the wing down force system transfers from the planter center to the wings.
Wing DF Pressure		This window reports the measured pressure to the wing down force system.

ADVANCED SEED INFORMATION (ASI) WINDOWS

The following table provides a quick overview of the additional windows that are available when Advanced Seed Information (ASI) has been activated.

NOTE: The following windows are not available until ASI has been activated. Contact your dealer for an activation code. See the AFS Pro 700 display software operating guide for information about the "Feature Activation" screen.

Placement label	“Run” screen window	Description
ASI Graph 2x2		This window reports the ASI averages for the entire planter and displays a graph of individual row unit performance. For the applicable crop types, the graphs' colors are determined by the ASI threshold settings. See 3-40.
ASI Multiples Avg		This window reports the average multiples percentage for the entire planter.
ASI Multiples Scan		This window reports the percentage of multiples for each seed meter, one row at a time, followed by the percentage for each section and the average for the entire planter.
ASI SRI Avg		This window reports the Seed Release Index (SRI) for the entire planter.
ASI SRI Scan		This window reports the Seed Release Index (SRI) for each seed meter, one row at a time, followed by the average for the entire planter.

Placement label	“Run” screen window	Description
ASI Singul. Grph 1x1		This window displays the singulation percentage for each row in bar graph form. For the applicable crop types, the graphs' colors are determined by the ASI threshold settings.
ASI Singulation Avg		This window reports the average singulation percentage for all planter rows.
ASI Singulation Scan		This window reports the current singulation percentage for each seed meter, one row at a time, followed by the average percentage for each planter section, the percentage for the rows currently reporting the high and low values, and the average percentage for the entire planter.
ASI Skips Avg		This window reports the average skip percentage for the entire planter.
ASI Skips Scan		This window reports the percentage of skips for each seed meter, one row at a time, followed by the percentage for each section and the average for the entire planter.

PREPARING FOR STORAGE

Proper planter storage practices are a key element in maintaining your planter's accuracy and efficiency. Refer to the planter Operator's Manual for specific steps to secure your machine for storage.

1. Fold planter markers. Install storage locks on carrying wheel hydraulic cylinders and drawbar hitch cylinders (if applicable).
2. Make sure tires are properly inflated.
3. Disconnect hydraulic and electrical lines. Cover connectors to prevent dirt contamination during storage.
4. Remove and clean seed meters. Inspect parts for wear. Reassemble meter covers to meter housings.
5. Completely empty and clean bulk hoppers and seed boxes. *SpeedTube units only* – Remove belt and clean out all debris. Inspect components for wear and ensure belt moves freely. Clean optical sensors, and reinstall SpeedTube components before reinstalling into row unit.
6. Liquid Fertilizer system (if equipped) – Drain and flush out liquid fertilizer tanks as specified in the Operator's Manual. Disconnect and clean components for storage. If freezing is expected over winter, fill the system with non-toxic, non-corrosive RV antifreeze (propylene-glycol).
7. Coat exposed hydraulic cylinder rods with grease to prevent rust.
8. Clean ground-engaging parts, and coat with grease or Case IH TILCOAT to prevent rust during storage. (Purchase TILCOAT from your Case IH dealer in aerosol, part number 1132221N, or in larger bulk containers)
9. Following proper procedures for handling farm chemicals, clean granular chemical hoppers. Re-install hoppers to their original row units.
10. Clean and lubricate the planter. Use touch-up paint as necessary.
11. Check ground engaging components for wear, and replace as needed
12. Inspect electrical harnesses and hydraulic hoses. Make necessary repairs to worn or damaged areas.
13. Clean and inspect the vacuum system.
14. Check and re-tighten hardware.
15. Remove and charge battery. Store indoors and off ground.





CNH Industrial America LLC reserves the right to make improvements in design and changes in specifications at any time without notice and without incurring any obligation to install them on units previously sold. Specifications, descriptions and illustrative material herein are as accurate as known at time of publication, but are subject to change without notice. Availability of some models and equipment builds varies according to the country in which the equipment is used.

CIH23030101 03/2023

©2023 CNH Industrial America LLC. All rights reserved. Case IH is a trademark registered in the United States and many other countries, owned by or licensed to CNH Industrial N.V., its subsidiaries or affiliates.

www.caseih.com

CASE IH